



CATALOG



ipd was founded and originated in the dental sector, specializing in the manufacturing and marketing of PROSTHETIC ABUTMENTS for DENTAL IMPLANTS. Available in more than thirty countries, **ipd** offers a wide range of superior quality products, providing innovative solutions in the field of dental implants/prosthetics. **ipd** is now a global leader in compatible abutments.



Who we are

About us

Our products are manufactured utilizing advanced technology and adhering to the highest quality standards. This includes constant supervision of the exact geometric dimensions and hygiene requirements for the abutments. The components are manufactured under the strictest parameters and procedures established by our engineers in close collaboration with recognised professionals and dentists.

A little background information

We have been operating in Spain since 2004, offering the widest range of dental abutments compatible with the main implant brands. Our goal is to offer technically advanced products of the highest quality and provide the best solutions to our customers.

Quality assurance

At *ipd*, the quality and excellence in our products is of highest priority.

We operate with the strictest quality control standards to manufacture products that perform and exceed market expectations.

The following certificates demonstrate our commitment:

- **ISO 9001**
Quality Management Assurance.
- **ISO 13485**
Medical Device Manufacturing Quality Management Assurance.
- **CE MARK** on all of our products.
- **MDSAP Medical Device Single Audit Program.**



Custom Ti-Base System

Get to know the new design

Advantages of the new design:

- New single position **asymmetrical, tri-lobe**, engaging design.
- **Easier to mill** geometry.
- **Spiral grooves** for improved retention.
- **Larger surface area for the prosthetic restoration** to avoid insufficient thickness depending on the materials used.
- **3 different platforms: Narrow, Regular and Wide.** The emergence profile can be reduced from the implant platform to the base of the prosthetic restoration.
- **Adjustable height:** With 8 mm as standard for engaging versions and 6.5 mm for non-engaging.
- The recess for the angled screw channel can be adjusted to all available heights, for both engaging and non-engaging
- **CAD/CAM libraries** are available for all variations.
- Different **gingival heights** for up to 3.5 mm.
- **Cutting guides** with fixation screw facilitate cutting and milling.

- 1 Trilobular engaging design
- 2 Helical grooves
- 3 Larger support surface for the prosthesis
- 4 Adjustable height
- 5 Recess for ASC at all available heights
- 6 Cutting guides

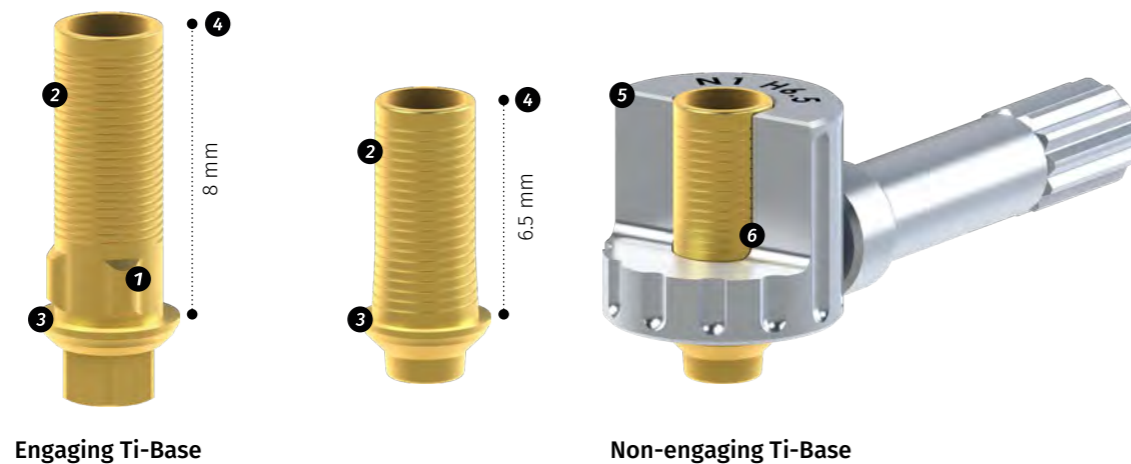

Engaging Ti-Base

With a height of 8mm, the engaging Ti-Base can be trimmed to several levels (6.5 mm / 5 mm / 3.5 mm), depending on the requirements for each task.

Adjusting the height is practical and simple using the cutting guides and fixation screw, making it possible to create the recess for the angled screw channel for every available height from 6.5 mm.

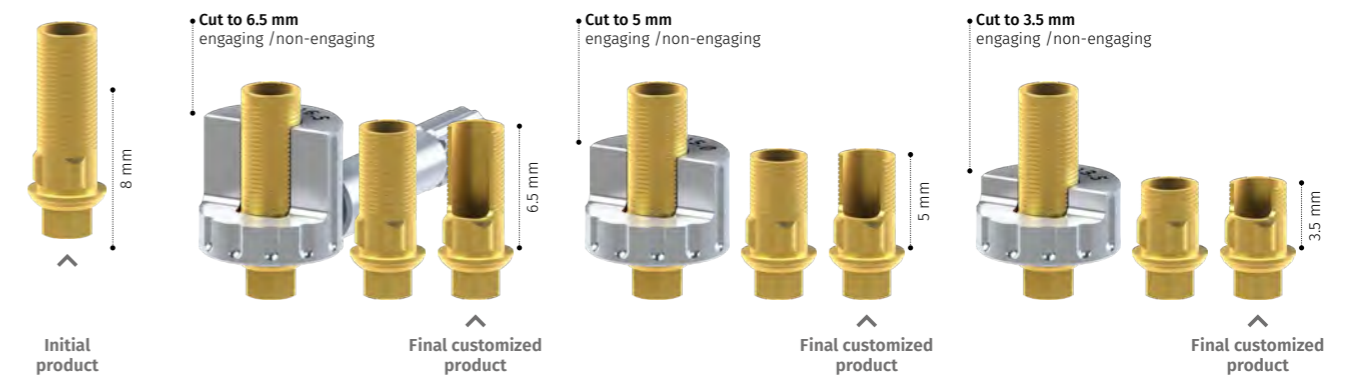

Non-engaging Ti-Base

With a standard height up to 6.5 mm, the non-engaging Ti-Base can be trimmed to various levels (5 mm / 3.5 mm). The height can be adjusted in the same way as the engaging Ti-Base, depending on the requirements of each case, using the cutting guides and the transverse fixation screw.

The recess for angled screw channel can also be prepared for every available height.

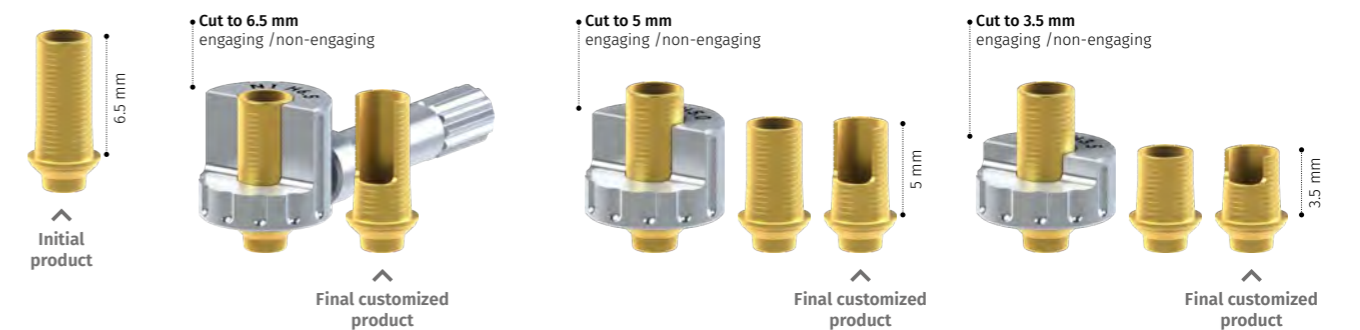

Scan Abutment

- Compatible with **intraoral systems** (clinical) and with **desktop systems** (laboratory).
- Also compatible with the **Renishaw® probe system**.
- **It includes a captive screw** to prevent loss and make it easier to mount.
- **The TiN coating** offers antibacterial properties to protect the gingiva.
- **The Titanium base** ensures a long-lasting connection and enables the use of Rx.
- The top section is made of **PEEK**, a polymer that favours implant reading and location.
- **Maximum Z-precision**, as it rests on the sagittal plane of the implant or analog.
- **A tolerance of ± 5 microns** throughout the entire manufacturing process.
- Reference engraved by **laser etching**.
- **2 heights for engaging:** 10 mm for most cases, and 15 mm for situations involving a very deep implant.

- 1 Captive screw
- 2 TiN coating
- 3 Titanium base
- 4 Upper portion of the abutment in PEEK
- 5 The highest possible precision on the Z-axis
- 6 Laser etched
- 7 2 heights for engaging versions

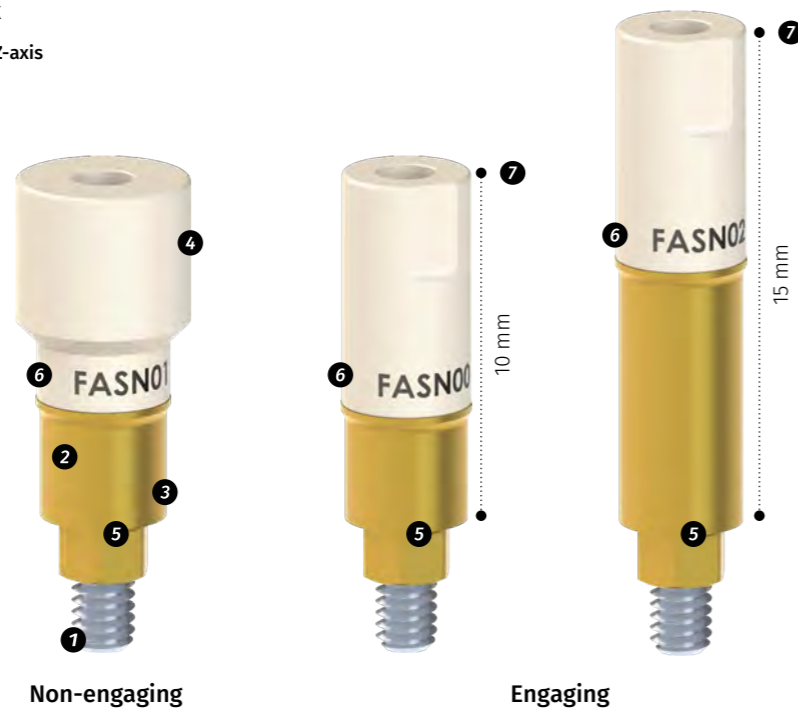

Correct Best fit

Our CAD libraries have up to 7 different Scan Abutment tolerances and adapt to the accuracy of each type of scanner on the market today.

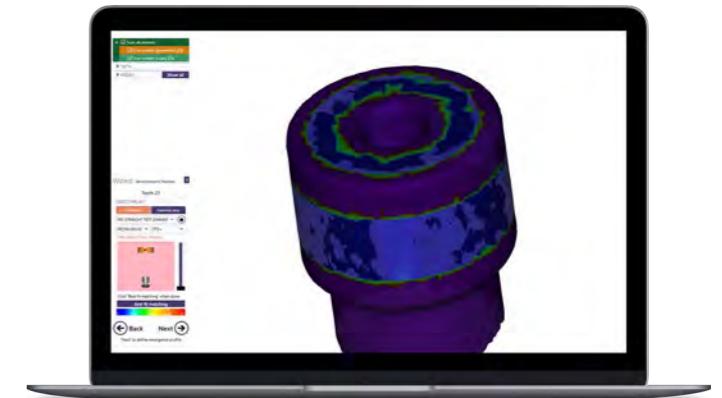

Scanned model



NOK. Best fit with wrong tolerance

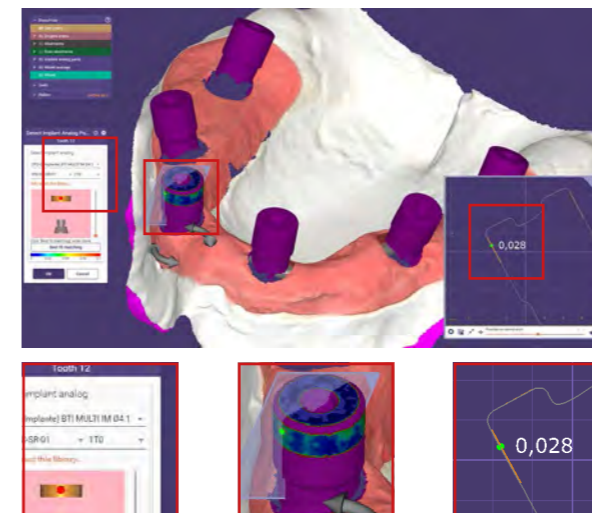

OK. Best fit with optimal tolerance

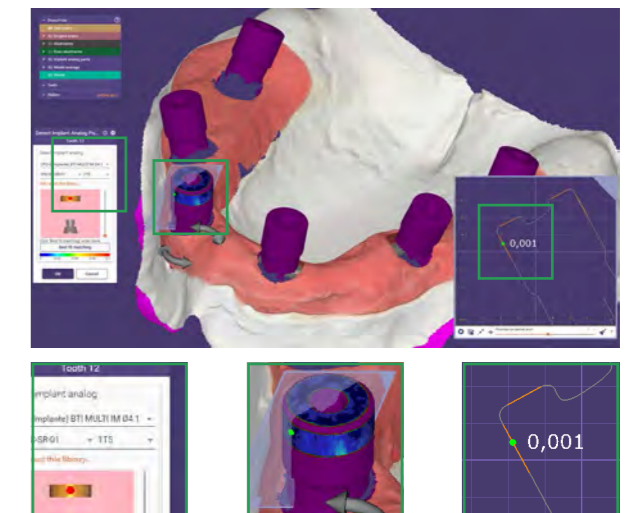

Digital Analog

The innovative design of our Digital Analog, with two fixation screws, **ensures the exact positioning** of the Analog in a 3D printed model.

The two fixation screws ensure that the Analog is in the correct position, with one located laterally and the other positioned at the bottom of the 3D printed model.

The lateral screw also enables the use of an articulator without loss of the bite registration.

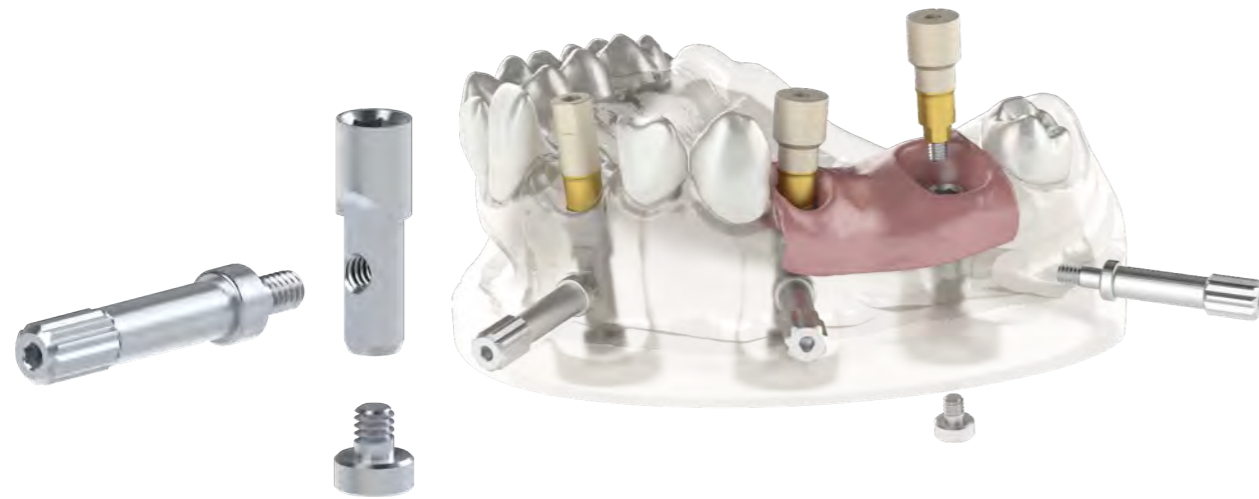

new Validation master

IPD has a **CAD library for a 3D model generator**.

We provide a validation master STL file so that you can check the printing resolution of your 3D printer. Once the tolerance is checked and validated, we will send you a customized CAD Library with optimized parameters. **We have up to 11 CAD library configurations with different tolerances** to ensure it that it will work efficiently with your 3D printing system.

To simplify this process, we also provide you with a digital analogue fixture, that allows you to test the adjustment on the calibration master in a convenient, simple and fast way.



Multi-unit system

The Multi-unit system has evolved to offer better features and new functionalities.

Find out everything that the Multi-unit system can do to **improve** your workflow.

Straight Multi-unit for one-piece abutments

We modify every Multi-unit to incorporate an **engaging design** that is adaptable to one-piece abutments. Thanks to this new functionality, all straight Multi-units can be used to solve cases which require the positioning of a single crown restoration. The corresponding prosthetic components fulfil this new functionality in order to work either analog or digitally. This morphology change does not affect the usual multi-unit procedures.



Engaging
abutments >

✓
+ Carrier

TiN coating

The Multi-unit abutments are coated with Titanium Nitride (TiN). This coating enhances the aesthetics of the abutment with a **gold colour**. This visually improves cases where patients have exposure of the trans mucosal abutment, and the case is compromised. It also provides antibacterial properties that prevent the adhesion of micro-particles that could result in soft tissue inflammation. The TiN coating is applied to all straight and angled Multi-units.

Carrier

The transfer of the abutment to the patient is more convenient with the new carrier for straight Multi-units. It fits securely onto the implant. Every order for a straight or angled Multi-unit comes with a carrier free of charge.

Discover our digital solutions CAD Libraries



Our scanning abutment system is the most integrated solution on the market allowing you to use a wide range of CAD libraries.

Our Scan Abutments Extra-/Intra-Oral - System can be used to carry out direct and indirect implant restorations, cemented or screwed-retained, 3D models, hybrids, among other functionalities that will soon be available in order to make the most of our Scan Abutments.

Direct Implant

With IPD's direct implant library you can design all types of structures that can be secured directly to the implant Ti-Base.



Hybrid direct implant

This is our innovative and cost-effective solution for direct implant digital tasks. It enables the manufacturing of prosthetics with high precision machined finishes and with reduced cost for the sintering process.

This hybrid library, unlike the others, consist of two phases in the manufacturing process:

- Sintering and Re-machining.
- This process ensures the best possible fit, a good finish and the highest possible precision in the most critical areas of implant prosthetics.



- 1 Sintered
- 2 Sintered + Re-machined

The hybrid library can be used to design frameworks in the traditional manner with CAD software and to export the STL file to one of our certified facilities in Spain or Europe.

All our libraries are available for the following CAD systems:

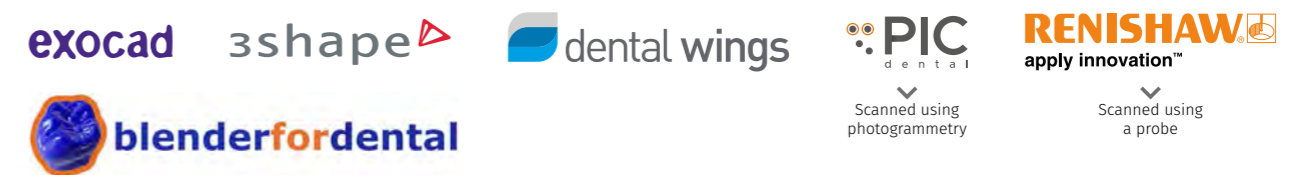

Indirect implant – Ti-Base

We also offer an indirect implant library for our innovative Custom Ti-Base System.

This library enables the design of any type of prosthetic solution on a Ti-Base to produce cemented-screw retained restorations.

It is a versatile solution with good aesthetic finishes and multiple manufacturing options. We also provide two different tolerance options. One tolerance is tighter for manufacturing single abutments by milling (ceramic) and the other is passive for manufacturing bridges and single abutments by sintering (CrCo) or milling with PMMA.

The CAD libraries support every customized option, emergence profile, cylinder height and straight or angled screw channels, offered on each Custom Ti-Base.



3D digital model

3D models can be created by the use of a Desktop scanning device or an Intra-oral device thus making the workflow faster, easier and simpler. Tasks can be completed quickly and more cost effectively in combination with our high precision digital analogues.

Accuracy is ensured thanks to our 11 different tolerances that adapt to every print quality from the 3D printers available on the market today. We will help you to determine the settings that your printer offers and send you the most suitable library for your job.



Compatibilities

- **NOBEL BIOCARE®**
 - AA Serie BRANEMARK SYSTEM® [ø3.5 / ø4.1 / ø5.1] 17 >
 - AC Serie NOBEL REPLACE® SELECT [ø3.5 / ø4.3 / ø5] 21 >
 - AD Serie NOBEL ACTIVE® [ø3.0 / ø3.5 / ø4.3] 25 >
- **BIOMET® 3i®**
 - BA Serie OSSEOTITE® [ø3.4 / ø4.1 / ø5] 31 >
 - BB Serie CERTAIN® [ø3.4 / ø4.1 / ø5] 35 >
- **KLOCKNER®**
 - CA Serie SK2-NK2 [ø4.2] 41 >
 - CB Serie ESSENTIAL CONE® [ø4.5] 45 >
 - CC Serie KL™ [ø3.5 / ø4.1 / ø5.1] 49 >
 - CD Serie VEGA® [ø3.5 / ø4.0 / ø4.5] 53 >
- **STRAUMANN®**
 - DA Serie TISSUE LEVEL [ø4.8 RN / ø6.5 WN] 57 >
 - DB Serie BONE LEVEL [ø3.3 NC / ø4.1 RC] 61 >
 - DC Serie BLX® [RB/WB] 65 >
- **ASTRA®**
 - EA Serie OSSEOSPEED™ [ø3 / ø3.5-4 / ø4.5-5] 69 >
 - EB Serie EVOLUTION® [ø3.6 / ø4.2] 75 >
- **ZIMMER®**
 - FA Serie SCREW VENT® [ø3.5 / ø4.5 / ø5.7] 79 >
 - FB Serie SWISSPLUS® [ø4.8] 83 >
 - FC Serie EZTETIC® [ø3.1] 87 >
- **BTI®**
 - GA Serie EXTERNAL [ø3.5 / ø4.1 / ø5.5] 91 >
 - GB Serie INTERNAL UNIVERSAL® [Universal® ø4.1 / Wide ø5.5] 95 >
 - GC Serie MULTI-IM® [ø4.1] 99 >
- **MICRODENT®**
 - HA Serie SYSTEM [ø3.5 / ø4.2 / ø5.1] 103 >
 - HB Serie UNIVERSAL™ [ø3.5 / ø4.1 / ø5.1] 105 >
- **DENTSPLY®**
 - IA Serie XIVE® FRIADENT® [ø3.4 / ø3.8 / ø4.5] 109 >
 - IB Serie ANKYLOS® [C/X] 113 >
- **CAMLOG®**
 - JA Serie CAMLOG® [ø3.3 / ø3.8 / ø4.3] 117 >
- **BIOHORIZONS®**
 - LB Serie TAPERED INTERNAL [ø3 / ø3.5 / ø4.5 / ø5.7] 121 >

Some products may not be available in your country. Please contact your official distributor for more details.

- **SWEDEN & MARTINA®**
 - MA Serie OUTLINK® [ø3.3 / ø4.1 / ø5] 127 >
 - MB Serie PREMIUM™ KOHNO® [ø3.3 / ø3.8 / ø4.25 / ø5] 131 >
- **PHIBO®**
 - NA Serie TSH® [S2 / S3-S4 / S5] 135 >
- **OSSTEM IMPLANT®**
 - OB Serie TSIII [ø3.5 / ø4.0] 141 >
- **BIOTECH® DENTAL**
 - QB Serie KONTACT® [RP] 145 >
- **NEODENT®**
 - RB Serie GRAND MORSE™ GM [GM] 149 >
- **BEGO® SEMADOS®**
 - SB Serie SC/RS [ø3.25 / ø3.75 / ø4.1 / ø4.5] 153 >
- **MIS®**
 - TA Serie SEVEN® [Narrow 3.3 / Standard / Wide] 157 >
 - TB Serie C1 / V3® [Standard] 163 >
- **DIO®**
 - UB Serie UFII [NP / RP] 167 >
- **MEGAGEN®**
 - WA Serie ANYONE® [RP] 171 >
 - WB Serie ANYRIDGE® [ø4.0] 175 >
- **DENTIUM®**
 - XA Serie IMPLANTIUM® / SUPERLINE™ [RP] 179 >
- **MEDENTIS®**
 - YB Serie ICX [RP] 183 >

Working Systems

- **CUSTOM Ti-BASE SYSTEM** 188 >
- **MULTI-UNIT SYSTEM** 198 >
- **PSD SYSTEM** 208 >
- **HOLLOW SCREW SYSTEM** 216 >
- **ACCESSORIES** 224 >
- **TECHNICAL SPECIFICATIONS** 228 >



Download the catalog in other languages.



Download the English version of the catalog.

Compatibility
NOBEL BIOCARE®

AA Series
BRANEMARK SYSTEM®
[ϕ 3.5 / ϕ 4.1 / ϕ 5.1]





ANALOG / DIGITAL ANALOG

Platform	Reference	Digital reference
ϕ 3.5	IPD/AA-AN-00	IPD/AA-AN-00/3D
ϕ 4.1	IPD/AA-AR-00	IPD/AA-AR-00/3D
ϕ 5.1	IPD/AA-AW-00	IPD/AA-AW-00/3D
Lower Screw	-	IPD/KA-TA-00
Transverse Screw	-	IPD/KA-TA-01

SCREW

Platform	Screwdriver	Seat	Reference	TiN Reference
ϕ 3.5	Unigrip	Conical	IPD/AA-TN-00	IPD/AA-TN-00/TIN
	Unigrip	Conical	IPD/AA-TR-00	IPD/AA-TR-00/TIN
ϕ 4.1	Unigrip	Flat	IPD/AA-TR-02	IPD/AA-TR-02/TIN
	1.20 Hex	Low profile conical	IPD/AA-TR-01	IPD/AA-TR-01/TIN
ϕ 5.1	Unigrip	Conical	IPD/AA-TW-00	IPD/AA-TW-00/TIN
			IPD/AA-TW-01	IPD/AA-TW-01/TIN

The IPD/AA-TW-01 screw is compatible with the Ti-Bases IPD/AA-IW-02/3D and IPD/AA-IW-03/3D

 Lengths 18/25/32 mm. Please see page 225 for more information. >



 Lengths 18/25/32 mm. Please see page 224 for more information. >

TPA SCREW FOR ANGLED PROSTHESIS

Platform	Screwdriver	Seat	Reference
ϕ 3.5	TPA	Conical	IPD/AA-TN-50
ϕ 4.1	TPA	Conical	IPD/AA-TR-50
	TPA	Flat	IPD/AA-TR-52
ϕ 5.1	TPA	Conical	IPD/AA-TW-50



 Lengths 18/25/32 mm. Please see page 226 for more information. >

INTRA-ORAL / DESKTOP / CONTACT PROBE SCAN BODY

Platform	Height (mm)		
ϕ 3.5	10	IPD/AA-SN-00	IPD/AA-SN-01
	15	IPD/AA-SN-02	-
ϕ 4.1	10	IPD/AA-SR-00	IPD/AA-SR-01
	15	IPD/AA-SR-02	-
ϕ 5.1	10	IPD/AA-SW-00	IPD/AA-SW-01

Captive screw included. 1.20 Hex Screwdriver.

Ti-BASE

Platform	Height (mm)		
ϕ 3.5	1.5	IPD/AA-IN-02/3D	IPD/AA-IN-03/3D
	0.5	IPD/AA-IR-00/3D	IPD/AA-IR-01/3D
ϕ 4.1	1.5	IPD/AA-IR-02/3D	IPD/AA-IR-03/3D
	2.5	IPD/AA-IR-04/3D	IPD/AA-IR-05/3D
ϕ 5.1	1.3	IPD/AA-IW-02/3D	IPD/AA-IW-03/3D

High version of the non-engaging Custom Ti-Base subject to availability. Please see page 188 for the  accessories. >

STRAIGHT AND ANGLED MULTI-UNIT ABUTMENT

Straight, 17° & 30°

Platform	Height (mm)	Straight	17°	30°
ϕ 4.1	1.0	IPD/AB-MR-01	-	-
	2.0	IPD/AB-MR-02	IPD/AB-MR-12	-
	3.0	IPD/AB-MR-03	IPD/AB-MR-13	IPD/AB-MR-33
	4.0	IPD/AB-MR-04	IPD/AB-MR-14	IPD/AB-MR-34
	5.0	IPD/AB-MR-05	-	IPD/AB-MR-35

Our straight multi-units can be used for single and multiple restorations. Please see page 198 for the Multi-unit system accessories. >



STRAIGHT AND ANGLED CASTABLE ABUTMENT WITH A Co-Cr BASE



Straight, 15° & 25°

Platform	Angulation		
ϕ 3.5	Straight	IPD/AA-BN-00	IPD/AA-BN-01
	15°	IPD/AA-BN-10	IPD/AA-BN-11
	25°	IPD/AA-BN-20	IPD/AA-BN-21
ϕ 4.1	Straight	IPD/AA-BR-00	IPD/AA-BR-01
	15°	IPD/AA-BR-10	IPD/AA-BR-11
	25°	IPD/AA-BR-20	IPD/AA-BR-21

All angled castable abutments include a TPA screw.



Co-Cr 3D BASE / SCAN BODY

Platform				Scan Body
ϕ 3.5	Straight / Angled	IPD/AA-BN-00/3D	IPD/AA-BN-01/3D	IPD/SC-AN-B1
ϕ 4.1	Straight / Angled	IPD/AA-BR-00/3D	IPD/AA-BR-01/3D	IPD/SC-AN-B1



PSD OVERDENTURE ABUTMENT

Platform	Height (mm)	Reference
ϕ 3.5	1.0	IPD/AA-LN-01
	3.0	IPD/AA-LN-03
	5.0	IPD/AA-LN-05
	1.0	IPD/AA-LR-01
	2.0	IPD/AA-LR-02
ϕ 4.1	3.0	IPD/AA-LR-03
	4.0	IPD/AA-LR-04
	5.0	IPD/AA-LR-05

Please see page 208 for the PSD system accessories. >





COMPATIBILITY
AA Series **BRANEMARK SYSTEM®**
[ϕ 3.5 / ϕ 4.1 / ϕ 5.1]



TEMPORARY ABUTMENT/ OPEN TRAY COPING

Platform			Coping screw
ϕ 3.5	IPD/AA-PN-06	IPD/AA-PN-07	IPD/AA-TN-00/C
ϕ 4.1	IPD/AA-PR-06	IPD/AA-PR-07	IPD/AA-TR-00/C
ϕ 5.1	IPD/AA-PW-06	IPD/AA-PW-07	IPD/AA-TW-00/C

The same abutment can be used as a temporary abutment with the occlusal screw or as an impression coping using the coping screw.

For references IPD/AA-PW-06 and IPD/AA-PW-07 use the screw IPD/AA-TW-01 if it is used as a temporary.



OPEN AND CLOSED TRAY COPING

Platform		Reference
ϕ 4.1	Open tray coping	IPD/AA-CR-00
	Closed tray coping	IPD/AA-CR-01
ϕ 5.1	Open tray coping	IPD/AA-CW-00

Classic design.



HEALING ABUTMENT

Platform	Height (mm)	Reference
ϕ 3.5	2.0	IPD/AA-DN-02
	3.0	IPD/AA-DN-03
	4.0	IPD/AA-DN-04
ϕ 4.1	2.0	IPD/AA-DR-02
	3.0	IPD/AA-DR-03
	4.0	IPD/AA-DR-04
ϕ 5.1	5.0	IPD/AA-DR-05
	2.0	IPD/AA-DW-02
	3.0	IPD/AA-DW-03
	4.0	IPD/AA-DW-04



STRAIGHT AND ANGLED ABUTMENT

Straight, 15° & 25°

Platform	Height (mm)	Angulation		
ϕ 4.1	1.0	Straight	IPD/AA-PR-00	IPD/AA-PR-01
		15°	IPD/AA-PR-02	-
		25°	IPD/AA-PR-03	-
		15°	IPD/AA-PR-04	-
		25°	IPD/AA-PR-05	-

Using the low profile IPD/AA-TR-01 screw for IPD/AA-PR-03 is recommended.



CASTABLE

Platform		
ϕ 4.1	IPD/AA-HR-00	IPD/AA-RR-00
ϕ 5.1	IPD/AA-HW-00	IPD/AA-RW-00



Compatibility
NOBEL BIO CARE®

AC Series
NOBEL REPLACE® SELECT
[ϕ 3.5 / ϕ 4.3 / ϕ 5.0]

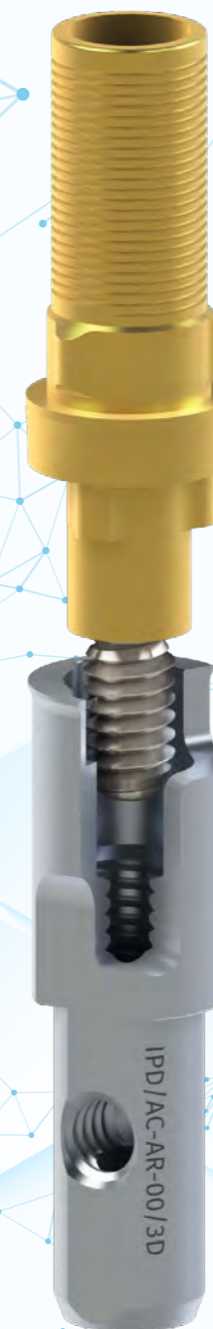



ANALOG / DIGITAL ANALOG

Platform	Reference	Digital reference
ϕ 3.5	IPD/AC-AN-00	IPD/AC-AN-00/3D
ϕ 4.3	IPD/AC-AR-00	IPD/AC-AR-00/3D
ϕ 5.0	IPD/AC-AW-00	IPD/AC-AW-00/3D
Lower Screw	-	IPD/KA-TA-00
Transverse Screw	-	IPD/KA-TA-01

SCREW

Platform	Screwdriver	Seat	Reference	TiN Reference
ϕ 3.5	Unigrip	Flat	IPD/AC-TN-00	IPD/AC-TN-00/TIN
ϕ 4.3 ϕ 5.0	Unigrip	Flat	IPD/AC-TR-00	IPD/AC-TR-00/TIN

Lengths 18/25/32 mm. Please see page 225 for more information. >

TPA SCREW FOR ANGLED PROSTHESIS

Platform	Screwdriver	Seat	Reference
ϕ 3.5	TPA	Flat	IPD/AC-TN-50
	TPA	Flat	IPD/AC-TN-51
ϕ 4.3 ϕ 5.0	TPA	Flat	IPD/AC-TR-50
	TPA	Flat	IPD/AC-TR-51

Lengths 18/25/32 mm. Please see page 226 for more information. >

IPD/AC-TN-51 is a specific screw for angled Ti-Bases **Hollow Screw System®**, IPD/AC-BN-20, and IPD/AC-BN-21.
IPD/AC-TR-51 is specific for angled Ti-Bases **Hollow Screw System®** and Cr-Co from IPD 2004.

INTRA-ORAL / DESKTOP / CONTACT PROBE SCAN BODY

Platform	Height (mm)		
ϕ 3.5	10	IPD/AC-SN-00	IPD/AC-SN-01
	15	IPD/AC-SN-02	-
ϕ 4.3	10	IPD/AC-SR-00	IPD/AC-SR-01
	15	IPD/AC-SR-02	-
ϕ 5.0	10	IPD/AC-SW-00	IPD/AC-SW-01
	15	IPD/AC-SW-02	-

Captive screw included. 1.20 Hex Screwdriver.

Ti-BASE **Custom Interface System™**

Platform	Height (mm)		
ϕ 3.5	0.5	IPD/AC-IN-00/3D	IPD/AC-IN-01/3D
	1.5	IPD/AC-IN-02/3D	IPD/AC-IN-03/3D
ϕ 4.3	0.5	IPD/AC-IR-00/3D	IPD/AC-IR-01/3D
	1.5	IPD/AC-IR-02/3D	IPD/AC-IR-03/3D
ϕ 5.0	0.5	IPD/AC-IW-00/3D	IPD/AC-IW-01/3D
	1.5	IPD/AC-IW-02/3D	IPD/AC-IW-03/3D

High version of the non-engaging Custom Ti-Base subject to availability.
Please see page 188 for the **Custom Interface System™** accessories. >

STRAIGHT AND ANGLED MULTI-UNIT ABUTMENT

Platform	Height (mm)	Straight	17°	30°
ϕ 3.5	1.0	IPD/AC-MN-01	-	-
	2.0	IPD/AC-MN-02	-	-
ϕ 4.3	1.0	IPD/AC-MR-01	-	-
	2.0	IPD/AC-MR-02	IPD/AC-MR-12	-
	3.0	IPD/AC-MR-03	IPD/AC-MR-13	-
	4.0	IPD/AC-MR-04	-	IPD/AC-MR-34
	5.0	IPD/AC-MR-05	-	-

Our straight multi-units can be used for single and multiple restorations.
Please see page 198 for the Multi-unit system accessories. >



STRAIGHT AND ANGLED CASTABLE ABUTMENT WITH A Co-Cr BASE

Platform	Angulation		
ϕ 3.5	Straight	IPD/AC-BN-00	IPD/AC-BN-01
	15°	IPD/AC-BN-10	IPD/AC-BN-11
	25°	IPD/AC-BN-20	IPD/AC-BN-21
ϕ 4.3	Straight	IPD/AC-BR-00	IPD/AC-BR-01
	15°	IPD/AC-BR-10	IPD/AC-BR-11

All angled castable abutments include a TPA screw.



Co-Cr 3D BASE / SCAN BODY

Platform				Scan Body
ϕ 3.5	Straight	IPD/AC-BN-00/3D	IPD/AC-BN-01/3D	IPD/SC-AN-B1
	Angled	IPD/AC-BN-A0/3D	IPD/AC-BN-A1/3D	IPD/SC-AN-B1
ϕ 4.3	Straight	IPD/AC-BR-00/3D	IPD/AC-BR-01/3D	IPD/SC-AN-B1
	Angled	IPD/AC-BR-A0/3D	IPD/AC-BR-A1/3D	IPD/SC-AN-B1



PSD OVERDENTURE ABUTMENT

Platform	Height (mm)	Reference
ϕ 3.5	3.0	IPD/AC-LN-03
	5.0	IPD/AC-LN-05
ϕ 4.3	1.0	IPD/AC-LR-01
	3.0	IPD/AC-LR-03
	5.0	IPD/AC-LR-05

Please see page 208 for the PSD system accessories. >





COMPATIBILITY
AC Series NOBEL REPLACE® SELECT
[ϕ 3.5 / ϕ 4.3 / ϕ 5.0]



TEMPORARY ABUTMENT/ OPEN TRAY COPING

Platform			Coping screw
ϕ 3.5	IPD/AC-PN-06	IPD/AC-PN-07	IPD/AC-TN-00/C
ϕ 4.3	IPD/AC-PR-06	IPD/AC-PR-07	IPD/AC-TR-00/C

The same abutment can be used as a temporary abutment with the occlusal screw or as an impression coping using the coping screw.

OPEN AND CLOSED TRAY COPING

Platform		Reference
ϕ 3.5	Closed tray coping	IPD/AC-CN-01
ϕ 4.3	Closed tray coping	IPD/AC-CR-01
ϕ 5.0	Open tray coping	IPD/AC-CW-00

Classic design.

HEALING ABUTMENT

Platform	Height (mm)	Reference
ϕ 3.5	3.0	IPD/AC-DN-03
	5.0	IPD/AC-DN-05
	7.0	IPD/AC-DN-07
ϕ 4.3	3.0	IPD/AC-DR-03
	5.0	IPD/AC-DR-05
	3.0	IPD/AC-DW-03
ϕ 5.0	5.0	IPD/AC-DW-05

STRAIGHT ABUTMENT

Platform	Reference
ϕ 3.5	IPD/AC-PN-00
ϕ 4.3	IPD/AC-PR-00
ϕ 5.0	IPD/AC-PW-00

CASTABLE

Platform		
ϕ 4.3	IPD/AC-HR-00	IPD/AC-RR-00
ϕ 5.0	IPD/AC-HW-00	IPD/AC-RW-00



Compatibility
NOBEL BIO CARE®

AD Series NOBEL ACTIVE®
[ϕ 3.0 / ϕ 3.5 / ϕ 4.3]

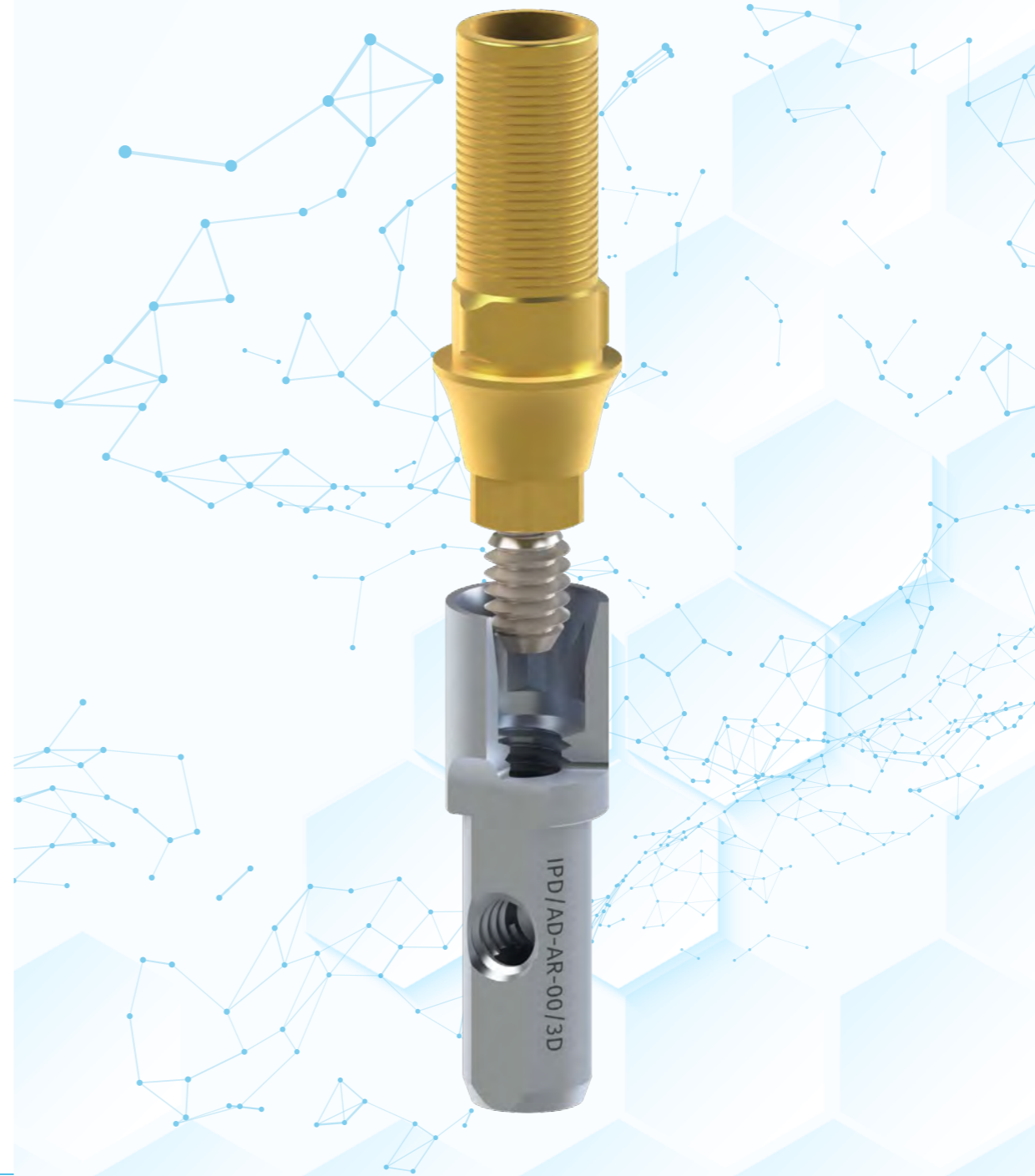

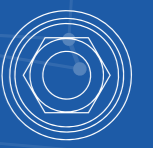

ANALOG / DIGITAL ANALOG

Platform	Reference	Digital reference
ϕ 3.0	IPD/AD-AT-00	IPD/AD-AT-00/3D
ϕ 3.5	IPD/AD-AN-00	IPD/AD-AN-00/3D
ϕ 4.3	IPD/AD-AR-00	IPD/AD-AR-00/3D
Lower Screw	-	IPD/KA-TA-00
Transverse Screw	-	IPD/KA-TA-01



SCREW

Platform	Screwdriver	Seat	Reference	TiN Reference
ϕ 3.0	Unigrip	Conical	IPD/AD-TT-00	IPD/AD-TT-00/TIN
ϕ 3.5	Unigrip	Conical	IPD/AA-TN-00	IPD/AA-TN-00/TIN
ϕ 4.3	Unigrip	Conical	IPD/AA-TR-00	IPD/AA-TR-00/TIN

 Lengths 18/25/32 mm. Please see page 225 for more information. >

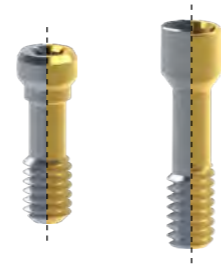



TPA SCREW FOR ANGLED PROSTHESIS

Platform	Screwdriver	Seat	Reference
ϕ 3.0	TPA	Conical	IPD/AD-TT-50
ϕ 3.5	TPA	Conical	IPD/AA-TN-50
ϕ 4.3	TPA	Conical	IPD/AD-TR-50

 Lengths 18/25/32 mm. Please see page 226 for more information. >





INTRA-ORAL / DESKTOP / CONTACT PROBE SCAN BODY

Platform	Height (mm)		
ϕ 3.0	10	IPD/AD-ST-00	IPD/AD-ST-01
	15	IPD/AD-ST-02	-
ϕ 3.5	10	IPD/AD-SN-00	IPD/AD-SN-01
	15	IPD/AD-SN-02	-
ϕ 4.3	10	IPD/AD-SR-00	IPD/AD-SR-01
	15	IPD/AD-SR-02	-

Captive screw included. 1.20 Hex Screwdriver.



Ti-BASE

Platform	Height (mm)		
ϕ 3.0	0.8	IPD/AD-IT-00/3D	IPD/AD-IT-01/3D
	1.5	IPD/AD-IT-02/3D	IPD/AD-IT-03/3D
	2.5	IPD/AD-IT-04/3D	IPD/AD-IT-05/3D
ϕ 3.5	0.5	IPD/AD-IN-00/3D	IPD/AD-IN-01/3D
	1.5	IPD/AD-IN-02/3D	IPD/AD-IN-03/3D
	2.5	IPD/AD-IN-04/3D	IPD/AD-IN-05/3D
ϕ 4.3	0.5	IPD/AD-IR-00/3D	IPD/AD-IR-01/3D
	1.5	IPD/AD-IR-02/3D	IPD/AD-IR-03/3D
	2.5	IPD/AD-IR-04/3D	IPD/AD-IR-05/3D

High version of the non-engaging Custom Ti-Base subject to availability. Please see page 188 for the  accessories. >



STRAIGHT AND ANGLED MULTI-UNIT ABUTMENT



Platform	Height (mm)	Straight	17°	30°
ϕ 3.5	1.5	IPD/AD-MN-01	-	-
	2.5	IPD/AD-MN-02	IPD/AD-MN-12	-
	3.5	IPD/AD-MN-03	IPD/AD-MN-13	IPD/AD-MN-33
	4.5	IPD/AD-MN-04	-	IPD/AD-MN-34
ϕ 4.3	1.5	IPD/AD-MR-01	-	-
	2.5	IPD/AD-MR-02	IPD/AD-MR-12	-
	3.5	IPD/AD-MR-03	IPD/AD-MR-13	IPD/AD-MR-33
	4.5	IPD/AD-MR-04	-	IPD/AD-MR-34

Our straight multi-units can be used for single and multiple restorations. Please see page 198 for the Multi-unit system accessories. >



STRAIGHT AND ANGLED CASTABLE ABUTMENT WITH A Co-Cr BASE

Straight, 15° & 25°

Platform	Angulation		
ϕ 3.0	Straight	IPD/AD-BT-00	IPD/AD-BT-01
	15°	IPD/AD-BT-10	IPD/AD-BT-11
	25°	IPD/AD-BT-20	IPD/AD-BT-21
ϕ 3.5	Straight	IPD/AD-BN-00	IPD/AD-BN-01
	15°	IPD/AD-BN-10	IPD/AD-BN-11
	25°	IPD/AD-BN-20	IPD/AD-BN-21
ϕ 4.3	Straight	IPD/AD-BR-00	IPD/AD-BR-01
	15°	IPD/AD-BR-10	IPD/AD-BR-11
	25°	IPD/AD-BR-20	IPD/AD-BR-21

All angled castable abutments include a TPA screw.





Co-Cr 3D BASE / SCAN BODY

Platform				Scan Body
ø3.0	Straight	IPD/AD-BT-00/3D	IPD/AD-BT-01/3D	IPD/SC-AN-B1
	Angled	IPD/AD-BT-A0/3D	IPD/AD-BT-A1/3D	IPD/SC-AN-B1
ø3.5	Straight / Angled	IPD/AD-BN-00/3D	IPD/AD-BN-01/3D	IPD/SC-AN-B1
	Straight	IPD/AD-BR-00/3D	IPD/AD-BR-01/3D	IPD/SC-AN-B1
ø4.3	Angled	IPD/AD-BR-A0/3D	IPD/AD-BR-A1/3D	IPD/SC-AN-B1



HEALING ABUTMENT

Platform	Height (mm)	Reference
ø3.0	3.0	IPD/AD-DT-03
	5.0	IPD/AD-DT-05
	7.0	IPD/AD-DT-07
ø3.5	Sealing cap	IPD/AD-DN-00
	1.5	IPD/AD-DN-01
	3.0	IPD/AD-DN-03
	5.0	IPD/AD-DN-05
	3.0 wide	IPD/AD-DN-13
	5.0 wide	IPD/AD-DN-15
	Sealing cap	IPD/AD-DR-00
ø4.3	1.5	IPD/AD-DR-01
	3.0	IPD/AD-DR-03
	5.0	IPD/AD-DR-05



PSD OVERDENTURE ABUTMENT

Platform	Height (mm)	Reference
ø3.5	1.0	IPD/AD-LN-01
	2.0	IPD/AD-LN-02
	3.0	IPD/AD-LN-03
	4.0	IPD/AD-LN-04
	5.0	IPD/AD-LN-05
ø4.3	1.0	IPD/AD-LR-01
	2.0	IPD/AD-LR-02
	3.0	IPD/AD-LR-03
	4.0	IPD/AD-LR-04
	5.0	IPD/AD-LR-05



CASTABLE

Platform		
ø4.3	IPD/AD-HR-00	IPD/AD-RR-00



Please see page 208 for the PSD system accessories. >

TEMPORARY ABUTMENT/ OPEN TRAY COPING

Platform			Coping screw
ø3.5	IPD/AD-PN-06	IPD/AD-PN-07	IPD/AD-TN-00/C
ø4.3	IPD/AD-PR-06	IPD/AD-PR-07	IPD/AD-TR-00/C

The same abutment can be used as a temporary abutment with the occlusal screw or as an impression coping using the coping screw.



OPEN TRAY COPING

Platform	Reference
ø3.0	IPD/AD-CT-00

Classic design.



Compatibility
BIOMET® 3i®

BA Series
OSSEOTITE®
[ϕ 3.4 / ϕ 4.1 / ϕ 5.0]





ANALOG / DIGITAL ANALOG

Platform	Reference	Digital reference
ϕ 3.4	IPD/BA-AN-00	IPD/BA-AN-00/3D
ϕ 4.1	IPD/AA-AR-00	IPD/AA-AR-00/3D
ϕ 5.0	IPD/BA-AW-00	IPD/BA-AW-00/3D
Lower Screw	-	IPD/KA-TA-00
Transverse Screw	-	IPD/KA-TA-01



SCREW

Platform	Screwdriver	Seat	Reference	TiN Reference
ϕ 3.4 ϕ 4.1 ϕ 5.0	1.20 Hex	Conical	IPD/BA-TR-00	IPD/BA-TR-00/TIN
	1.25 Hex	Conical	IPD/BA-TR-01	IPD/BA-TR-01/TIN
	Square	Flat	IPD/BA-TR-02	IPD/BA-TR-02/TIN
	1.20 Hex	Low profile conical	IPD/AA-TR-01	IPD/AA-TR-01/TIN

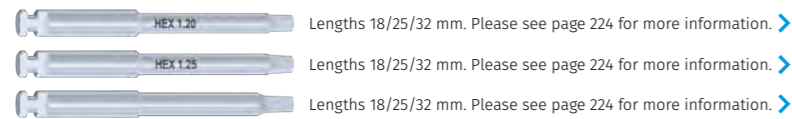

TPA SCREW FOR ANGLED PROSTHESIS

Platform	Screwdriver	Seat	Reference	TiN Reference
ϕ 3.4 ϕ 4.1 ϕ 5.0	TPA	Conical	IPD/AA-TR-50	IPD/AA-TR-50/TIN
		Flat	IPD/AA-TR-52	IPD/AA-TR-52/TIN



INTRA-ORAL / DESKTOP / CONTACT PROBE SCAN BODY

Platform	Height (mm)		
ϕ 3.4	10	IPD/BA-SN-00	IPD/BA-SN-01
	15	IPD/BA-SN-02	-
ϕ 4.1	10	IPD/AA-SR-00	IPD/AA-SR-01
	15	IPD/AA-SR-02	-
ϕ 5.0	10	IPD/BA-SW-00	IPD/BA-SW-01
	15	IPD/BA-SW-02	-

Captive screw included. 1.20 Hex Screwdriver.



Ti-BASE

Platform	Height (mm)		
ϕ 3.4	1.5	IPD/BA-IN-02/3D	IPD/BA-IN-03/3D
	0.5	IPD/AA-IR-00/3D	IPD/AA-IR-01/3D
ϕ 4.1	1.5	IPD/AA-IR-02/3D	IPD/AA-IR-03/3D
	2.5	IPD/AA-IR-04/3D	IPD/AA-IR-05/3D
ϕ 5.0	0.5	IPD/BA-IW-00/3D	IPD/BA-IW-01/3D
	1.5	IPD/BA-IW-02/3D	IPD/BA-IW-03/3D



High version of the non-engaging Custom Ti-Base subject to availability. Please see page 188 for the accessories. >

STRAIGHT AND ANGLED MULTI-UNIT ABUTMENT

Platform	Height (mm)	Straight	17°	30°
ϕ 4.1	1.0	IPD/AB-MR-01	-	-
	2.0	IPD/AB-MR-02	IPD/AB-MR-12	-
	3.0	IPD/AB-MR-03	IPD/AB-MR-13	IPD/AB-MR-33
	4.0	IPD/AB-MR-04	IPD/AB-MR-14	IPD/AB-MR-34
	5.0	IPD/AB-MR-05	-	IPD/AB-MR-35



Our straight multi-units can be used for single and multiple restorations. Please see page 198 for the Multi-unit system accessories. >

STRAIGHT AND ANGLED CASTABLE ABUTMENT WITH A Co-Cr BASE Straight, 15° & 25°

Platform	Angulation		
ϕ 3.4	Straight	IPD/BA-BN-00	IPD/BA-BN-01
	15°	IPD/BA-BN-10	IPD/BA-BN-11
	25°	IPD/BA-BN-20	IPD/BA-BN-21
ϕ 4.1	Straight	IPD/AA-BR-00	IPD/AA-BR-01
	15°	IPD/AA-BR-10	IPD/AA-BR-11
	25°	IPD/AA-BR-20	IPD/AA-BR-21
ϕ 5.0	Straight	IPD/BA-BW-00	IPD/BA-BW-01
	15°	IPD/BA-BW-10	IPD/BA-BW-11
	25°	IPD/BA-BW-20	IPD/BA-BW-21



All angled castable abutments include a TPA screw.

Co-Cr 3D BASE / SCAN BODY

Platform				Scan Body
ϕ 3.4	Straight / Angled	IPD/BA-BN-00/3D	IPD/BA-BN-01/3D	IPD/SC-AN-B1
ϕ 4.1	Straight / Angled	IPD/AA-BR-00/3D	IPD/AA-BR-01/3D	IPD/SC-AN-B1
ϕ 5.0	Straight / Angled	IPD/BA-BW-00/3D	IPD/BA-BW-01/3D	IPD/SC-AN-B1



PSD OVERDENTURE ABUTMENT

Platform	Height (mm)	Reference
ϕ 3.4	1.0	IPD/BA-LN-01
	3.0	IPD/BA-LN-03
	1.0	IPD/AA-LR-01
ϕ 4.1	2.0	IPD/AA-LR-02
	3.0	IPD/AA-LR-03
	4.0	IPD/AA-LR-04
	5.0	IPD/AA-LR-05



Please see page 208 for the PSD system accessories. >



COMPATIBILITY
BA Series OSSEOTITE®
 [ø3.4 / ø4.1 / ø5.0]



TEMPORARY ABUTMENT/ OPEN TRAY COPING

Platform			Coping screw
ø3.4	IPD/BA-PN-06	IPD/BA-PN-07	IPD/AA-TR-00/C
ø4.1	IPD/AA-PR-06	IPD/AA-PR-07	IPD/AA-TR-00/C

The same abutment can be used as a temporary abutment with the occlusal screw or as an impression coping using the coping screw.

OPEN AND CLOSED TRAY COPING

Platform		Reference
ø4.1	Open tray coping	IPD/AA-CR-00
	Closed tray coping	IPD/AA-CR-01
ø5.0	Open tray coping	IPD/BA-CW-00

Classic design.

HEALING ABUTMENT

Platform	Height (mm)	Reference
ø3.4	2.0	IPD/BA-DN-02
	3.0	IPD/BA-DN-03
	4.0	IPD/BA-DN-04
ø4.1	2.0	IPD/AA-DR-02
	3.0	IPD/AA-DR-03
	4.0	IPD/AA-DR-04
ø5.0	5.0	IPD/AA-DR-05
	2.0	IPD/BA-DW-02
	3.0	IPD/BA-DW-03
	4.0	IPD/BA-DW-04

STRAIGHT AND ANGLED ABUTMENT

Straight, 15° & 25°

Platform	Height (mm)	Angulation		
ø4.1	1.0	Straight	IPD/AA-PR-00	IPD/AA-PR-01
		15°	IPD/AA-PR-02	-
		25°	IPD/AA-PR-03	-
	2.0	15°	IPD/AA-PR-04	-
		25°	IPD/AA-PR-05	-

Using the low profile IPD/AA-TR-01 screw for IPD/AA-PR-03 is recommended.

CASTABLE

Platform		
ø4.1	IPD/AA-HR-00	IPD/AA-RR-00
ø5.0	IPD/BA-HW-00	IPD/BA-RW-00



Compatibility
BIOMET® 3i®
BB Series CERTAIN®
 [ø3.4 / ø4.1 / ø5.0]

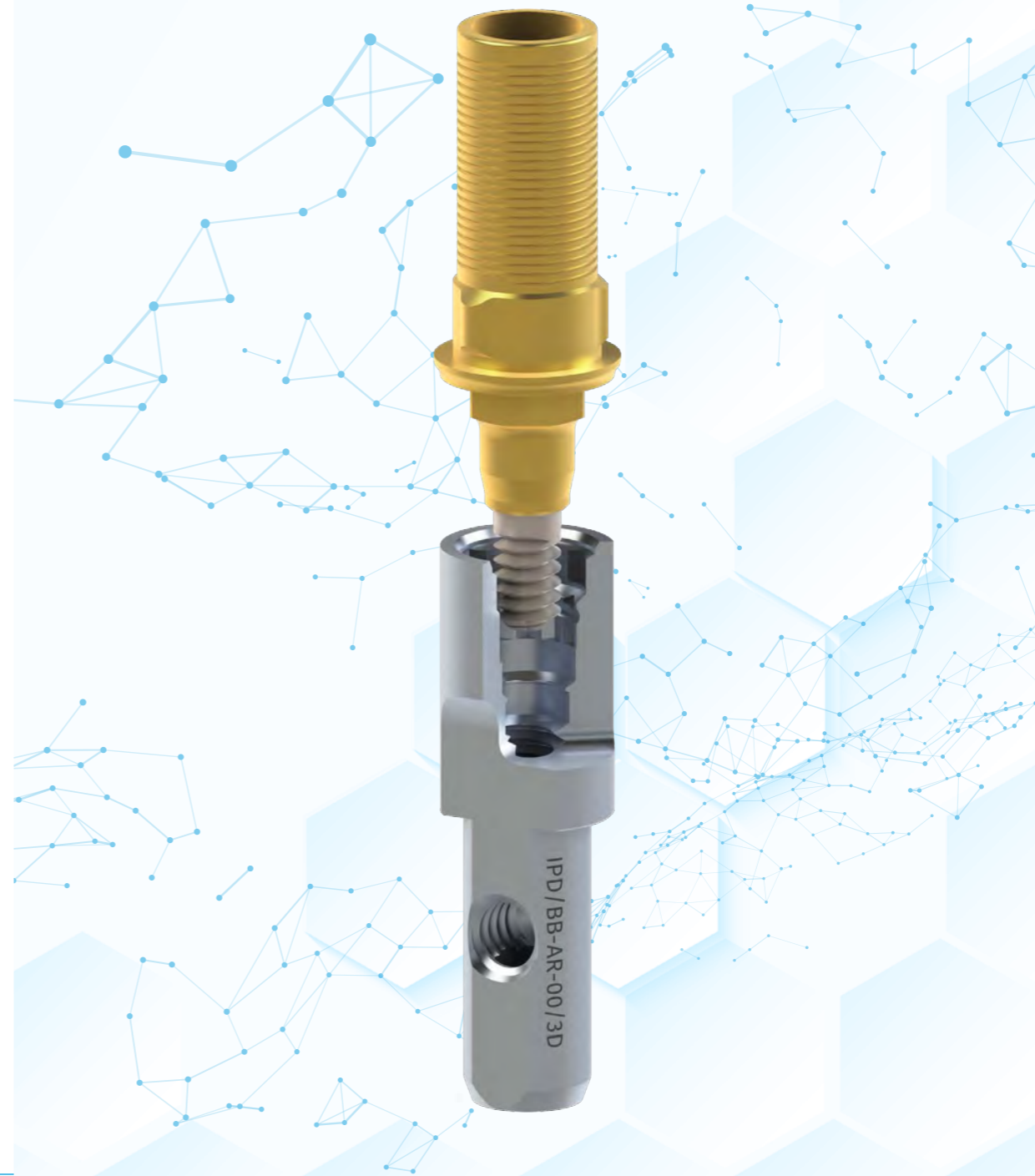



COMPATIBILITY
BB Series CERTAIN®
[ϕ 3.4 / ϕ 4.1 / ϕ 5.0]



COMPATIBILITY
BB Series CERTAIN®
[ϕ 3.4 / ϕ 4.1 / ϕ 5.0]



ANALOG / DIGITAL ANALOG

Platform	Reference	Digital reference
ϕ 3.4	IPD/BB-AN-00	IPD/BB-AN-00/3D
ϕ 4.1	IPD/BB-AR-00	IPD/BB-AR-00/3D
ϕ 5.0	IPD/BB-AW-00	IPD/BB-AW-00/3D
Lower Screw	-	IPD/KA-TA-00
Transverse Screw	-	IPD/KA-TA-01



SCREW

Platform	Screwdriver	Seat	Reference	TiN Reference
ϕ 3.4 ϕ 4.1 ϕ 5.0	1.20 Hex	Flat	IPD/BB-TR-01	IPD/BB-TR-01/TIN
ϕ 4.1 ϕ 5.0	1.20 Hex	Conical	IPD/BB-TR-02	-

IPD/BB-TR-02 is a specific screw for models IPD/BB-RR-00 and IPD/BB-RW-00

 Lengths 18/25/32 mm. Please see page 224 for more information. >





TPA SCREW FOR ANGLED PROSTHESIS

Platform	Screwdriver	Seat	Reference
ϕ 3.4 ϕ 4.1 ϕ 5.0	TPA	Flat	IPD/BB-TR-51

 Lengths 18/25/32 mm. Please see page 226 for more information. >





INTRA-ORAL / DESKTOP / CONTACT PROBE SCAN BODY

Platform	Height (mm)		
ϕ 3.4	10	IPD/BB-SN-00	IPD/BB-SN-01
	15	IPD/BB-SN-02	-
ϕ 4.1	10	IPD/BB-SR-00	IPD/BB-SR-01
	15	IPD/BB-SR-02	-
ϕ 5.0	10	IPD/BB-SW-00	IPD/BB-SW-01
	15	IPD/BB-SW-02	-

Captive screw included. 1.20 Hex Screwdriver.



Ti-BASE

Platform	Height (mm)		
ϕ 3.4	0.5	IPD/BB-IN-00/3D	IPD/BB-IN-01/3D
	1.5	IPD/BB-IN-02/3D	IPD/BB-IN-03/3D
	2.5	IPD/BB-IN-04/3D	IPD/BB-IN-05/3D
ϕ 4.1	0.5	IPD/BB-IR-00/3D	IPD/BB-IR-01/3D
	1.5	IPD/BB-IR-02/3D	IPD/BB-IR-03/3D
ϕ 5.0	0.5	IPD/BB-IW-00/3D	IPD/BB-IW-01/3D
	1.5	IPD/BB-IW-02/3D	IPD/BB-IW-03/3D

High version of the non-engaging Custom Ti-Base subject to availability. Please see page 188 for the  accessories. >



STRAIGHT AND ANGLED MULTI-UNIT ABUTMENT

Platform	Height (mm)	Straight	17°	30°
ϕ 4.1	1.0	IPD/BB-MR-01	-	-
	2.0	IPD/BB-MR-02	IPD/BB-MR-12	-
	3.0	IPD/BB-MR-03	IPD/BB-MR-13	-
	4.0	IPD/BB-MR-04	-	IPD/BB-MR-34
	5.0	IPD/BB-MR-05	-	-

Our straight multi-units can be used for single and multiple restorations. Please see page 198 for the Multi-unit system accessories. >



STRAIGHT AND ANGLED CASTABLE ABUTMENT WITH A Co-Cr BASE

Straight, 15° & 25°

Platform	Angulation		
ϕ 3.4	Straight	IPD/BB-BN-00	IPD/BB-BN-01
	15°	IPD/BB-BN-10	IPD/BB-BN-11
	25°	IPD/BB-BN-20	IPD/BB-BN-21
ϕ 4.1	Straight	IPD/BB-BR-00	IPD/BB-BR-01
	15°	IPD/BB-BR-10	IPD/BB-BR-11
	25°	IPD/BB-BR-20	IPD/BB-BR-21

All angled castable abutments include a TPA screw.







COMPATIBILITY
BB Series CERTAIN®
[ϕ 3.4 / ϕ 4.1 / ϕ 5.0]



COMPATIBILITY
BB Series CERTAIN®
[ϕ 3.4 / ϕ 4.1 / ϕ 5.0]



Co-Cr 3D BASE / SCAN BODY

Platform				Scan Body
ϕ 3.4	Straight	IPD/BB-BN-00/3D	IPD/BB-BN-01/3D	IPD/SC-AN-B1
	Angled	IPD/BB-BN-A0/3D	IPD/BB-BN-A1/3D	IPD/SC-AN-B1
ϕ 4.1	Straight / Angled	IPD/BB-BR-00/3D	IPD/BB-BR-01/3D	IPD/SC-AN-B1





PSD OVERDENTURE ABUTMENT

Platform	Height (mm)	Reference
ϕ 3.4	1.0	IPD/BB-LN-01
	3.0	IPD/BB-LN-03
	5.0	IPD/BB-LN-05
ϕ 4.1	1.0	IPD/BB-LR-01
	3.0	IPD/BB-LR-03
	5.0	IPD/BB-LR-05

Please see page 208 for the PSD system accessories.



TEMPORARY ABUTMENT/ OPEN TRAY COPING

Platform			Coping screw
ϕ 3.4	IPD/BB-PN-06	IPD/BB-PN-07	IPD/BB-TR-01/C
ϕ 4.1	IPD/BB-PR-06	IPD/BB-PR-07	IPD/BB-TR-01/C

The same abutment can be used as a temporary abutment with the occlusal screw or as an impression coping using the coping screw.



OPEN AND CLOSED TRAY COPING

Platform		Reference
ϕ 5.0	Open tray coping	IPD/BB-CW-00

Classic design.



HEALING ABUTMENT

Platform	Height (mm)	Reference
ϕ 3.4	2.0	IPD/BB-DN-02
	3.0	IPD/BB-DN-03
	4.0	IPD/BB-DN-04
ϕ 4.1	2.0	IPD/BB-DR-02
	3.0	IPD/BB-DR-03
	4.0	IPD/BB-DR-04
ϕ 5.0	2.0	IPD/BB-DW-02
	3.0	IPD/BB-DW-03
	4.0	IPD/BB-DW-04





STRAIGHT ABUTMENT

Platform	Reference
ϕ 3.4	IPD/BB-PN-00
ϕ 4.1	IPD/BB-PR-00
ϕ 5.0	IPD/BB-PW-00



CASTABLE

Platform		
ϕ 4.1	IPD/BB-HR-00	IPD/BB-RR-00
ϕ 5.0	IPD/BB-HW-00	IPD/BB-RW-00

Engaging castables should be used with the IPD/BB-TR-02 screw.



Compatibility
KLOCKNER®

CA Series
SK2-NK2
[Ø4.2]

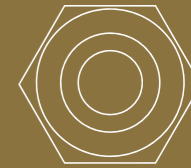

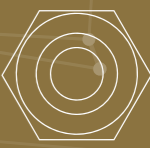

ANALOG / DIGITAL ANALOG

Platform	Reference	Digital reference
ϕ 4.2	IPD/CA-AR-00	IPD/CA-AR-00/3D
Lower Screw	-	IPD/KA-TA-00
Transverse Screw	-	IPD/KA-TA-01



STRAIGHT AND ANGLED CASTABLE ABUTMENT WITH A Co-Cr BASE

Platform	Angulation		
ϕ 4.2	Straight	IPD/CA-BR-00	IPD/CA-BR-01
	15°	IPD/CA-BR-10	IPD/CA-BR-11
	25°	IPD/CA-BR-20	IPD/CA-BR-21

All angled castable abutments include a TPA screw.



SCREW

Platform	Screwdriver	Seat	Reference	TiN Reference
ϕ 4.2	1.70 hexagon	Conical	IPD/CA-TR-00	IPD/CA-TR-00/TIN
	Cruciforme	Conical	IPD/CA-TR-01	IPD/CA-TR-01/TIN

HEX 1.70 Lengths 18/25/32 mm. Please see page 224 for more information. >

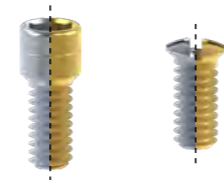

Co-Cr 3D BASE / SCAN BODY

Platform			Scan Body
ϕ 4.2	Straight / Angled	IPD/CA-BR-00/3D	IPD/CA-BR-01/3D
			IPD/SC-AN-B1



TPA SCREW FOR ANGLED PROSTHESIS

Platform	Screwdriver	Seat	Reference
ϕ 4.2	TPA	Conical	IPD/CA-TR-50

Lengths 18/25/32 mm. Please see page 226 for more information. >



TEMPORARY ABUTMENT/ OPEN TRAY COPING

Platform			Coping screw
ϕ 4.2	IPD/CA-PR-06	IPD/CA-PR-07	IPD/CA-TR-00/C

The same abutment can be used as a temporary abutment with the occlusal screw or as an impression coping using the coping screw.



INTRA-ORAL / DESKTOP / CONTACT PROBE SCAN BODY

Platform	Height (mm)		
ϕ 4.2	10	IPD/CA-SR-00	IPD/CA-SR-01

Captive screw included. 1.20 Hex Screwdriver.



HEALING ABUTMENT

Platform	Height (mm)	Reference
ϕ 4.2	5.0	IPD/CA-DR-00

Screw IPD/CA-TR-00 not included.



STRAIGHT ABUTMENT

Platform	Reference
ϕ 4.2	IPD/CA-PR-00



Ti-BASE Custom Interface System™

Platform	Height (mm)		
ϕ 4.2	2.25	IPD/CA-IR-04/3D	IPD/CA-IR-05/3D

High version of the non-engaging Custom Ti-Base subject to availability. Please see page 188 for the accessories. >



CASTABLE

Platform		
ϕ 4.2	IPD/CA-HR-00	IPD/CA-RR-00



Compatibility
KLOCKNER®
CB Series
ESSENTIAL CONE®
[Ø4.5]

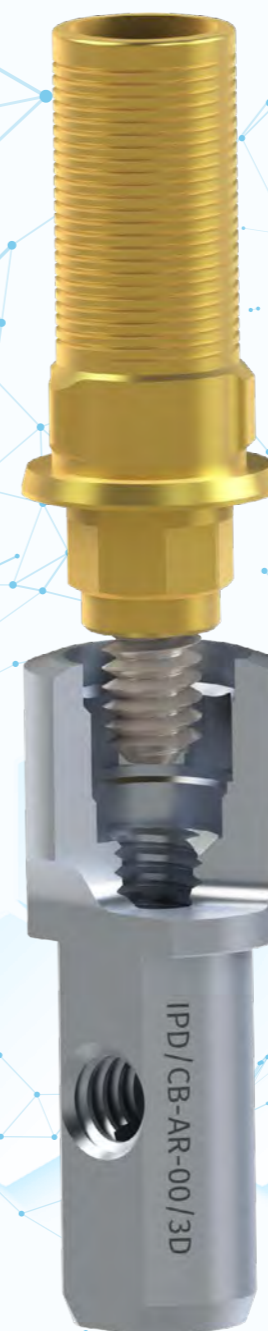
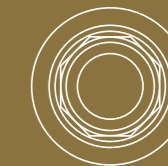

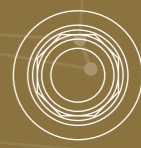
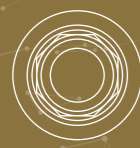

ANALOG / DIGITAL ANALOG

Platform	Reference	Digital reference
ø4.5	IPD/CB-AR-00	IPD/CB-AR-00/3D
Lower Screw	-	IPD/KA-TA-00
Transverse Screw	-	IPD/KA-TA-01



SCREW

Platform	Screwdriver	Seat	Reference	TiN Reference
ø4.5	Star	Conical	IPD/CB-TR-00	IPD/CB-TR-00/TiN

Implant level screw.



TPA SCREW FOR ANGLED PROSTHESIS

Platform	Screwdriver	Seat	Reference
ø4.5	TPA	Conical	IPD/CB-TR-50

Implant level screw.

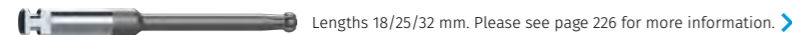

INTRA-ORAL / DESKTOP / CONTACT PROBE SCAN BODY

Platform	Height (mm)		
ø4.5	10	IPD/CB-SR-00	IPD/CB-SR-01
	15	IPD/CB-SR-02	-

Captive screw included. 1.20 Hex Screwdriver.



Ti-BASE

Platform	Height (mm)		
ø4.5	0.5	IPD/CB-IR-00/3D	IPD/CB-IR-01/3D

High version of the non-engaging Custom Ti-Base subject to availability. Please see page 188 for the accessories. >



STRAIGHT AND ANGLED CASTABLE ABUTMENT WITH A Co-Cr BASE Straight, 15° & 25°

Platform	Angulation		
ø4.5	Straight	IPD/CB-BR-00	IPD/CB-BR-01
	15°	IPD/CB-BR-10	IPD/CB-BR-11
	25°	IPD/CB-BR-20	IPD/CB-BR-21

All angled castable abutments include a TPA screw.



Co-Cr 3D BASE / SCAN BODY

Platform			Scan Body
ø4.5	Straight / Angled	IPD/CB-BR-00/3D	IPD/CB-BR-01/3D
			IPD/SC-AN-B2



PSD OVERDENTURE ABUTMENT

Platform	Height (mm)	Reference
ø4.5	1.0	IPD/CB-LR-01
	3.0	IPD/CB-LR-03

Please see page 208 for the PSD system accessories. >



TEMPORARY ABUTMENT/ OPEN TRAY COPING

Platform			Coping screw
ø4.5	IPD/CB-PR-06	IPD/CB-PR-07	IPD/CB-TR-00/C

The same abutment can be used as a temporary abutment with the occlusal screw or as an impression coping using the coping screw.



HEALING ABUTMENT

Platform	Height (mm)	Reference
ø4.5	1.5	IPD/CB-DR-01
	3.0	IPD/CB-DR-03
	4.5	IPD/CB-DR-05



Compatibility
KLOCKNER®

CC Series
KL™
[Ø3.5 / Ø4.1 / Ø5.1]





COMPATIBILITY
CC Series KL™
[ø3.5 / ø4.1 / ø5.1]



COMPATIBILITY
CC Series KL™
[ø3.5 / ø4.1 / ø5.1]



ANALOG / DIGITAL ANALOG

Platform	Reference	Digital reference
ø3.5	IPD/AA-AN-00	IPD/AA-AN-00/3D
ø4.1	IPD/AA-AR-00	IPD/AA-AR-00/3D
ø5.1	IPD/AA-AW-00	IPD/AA-AW-00/3D
Lower Screw	-	IPD/KA-TA-00
Transverse Screw	-	IPD/KA-TA-01



SCREW

Platform	Screwdriver	Seat	Reference	TiN Reference
ø3.5	Unigrip	Conical	IPD/AA-TN-00	IPD/AA-TN-00/TIN
ø4.1	Unigrip	Conical	IPD/AA-TR-00	IPD/AA-TR-00/TIN
	1.20 Hex	Conical	IPD/BA-TR-00	IPD/BA-TR-00/TIN
ø5.1	1.20 Hex	Low profile conical	IPD/AA-TR-01	IPD/AA-TR-01/TIN
	Unigrip	Conical	IPD/AA-TW-00	IPD/AA-TW-00/TIN

Lengths 18/25/32 mm. Please see page 225 for more information. >

Lengths 18/25/32 mm. Please see page 224 for more information. >

TPA SCREW FOR ANGLED PROSTHESIS

Platform	Screwdriver	Seat	Reference
ø3.5	TPA	Conical	IPD/AA-TN-50
ø4.1	TPA	Conical	IPD/AA-TR-50
		Flat	IPD/AA-TR-52
ø5.1	TPA	Conical	IPD/AA-TW-50

Lengths 18/25/32 mm. Please see page 226 for more information. >

INTRA-ORAL / DESKTOP / CONTACT PROBE SCAN BODY

Platform	Height (mm)		
ø3.5	10	IPD/AA-SN-00	IPD/AA-SN-01
	15	IPD/AA-SN-02	-
ø4.1	10	IPD/AA-SR-00	IPD/AA-SR-01
	15	IPD/AA-SR-02	-
ø5.1	10	IPD/AA-SW-00	IPD/AA-SW-01

Captive screw included. 1.20 Hex Screwdriver.

Ti-BASE Custom Interface System

Platform	Height (mm)		
ø3.5	1.5	IPD/AA-IN-02/3D	IPD/AA-IN-03/3D
	0.5	IPD/AA-IR-00/3D	IPD/AA-IR-01/3D
ø4.1	1.5	IPD/AA-IR-02/3D	IPD/AA-IR-03/3D
	2.5	IPD/AA-IR-04/3D	IPD/AA-IR-05/3D
ø5.1	1.3	IPD/AA-IW-00/3D	IPD/AA-IW-01/3D

High version of the non-engaging Custom Ti-Base subject to availability. Please see page 188 for the accessories. >

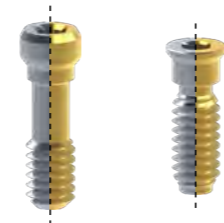

STRAIGHT AND ANGLED MULTI-UNIT ABUTMENT

Platform	Height (mm)	Straight	17°	30°
ø4.1	1.0	IPD/AB-MR-01	-	-
	2.0	IPD/AB-MR-02	IPD/AB-MR-12	-
	3.0	IPD/AB-MR-03	IPD/AB-MR-13	IPD/AB-MR-33
	4.0	IPD/AB-MR-04	IPD/AB-MR-14	IPD/AB-MR-34
	5.0	IPD/AB-MR-05	-	IPD/AB-MR-35



Our straight multi-units can be used for single and multiple restorations. Please see page 198 for the Multi-unit system accessories. >

STRAIGHT AND ANGLED CASTABLE ABUTMENT WITH A Co-Cr BASE

Straight, 15° & 25°

Platform	Angulation		
ø3.5	Straight	IPD/AA-BN-00	IPD/AA-BN-01
	15°	IPD/AA-BN-10	IPD/AA-BN-11
	25°	IPD/AA-BN-20	IPD/AA-BN-21
	Straight	IPD/AA-BR-00	IPD/AA-BR-01
ø4.1	15°	IPD/AA-BR-10	IPD/AA-BR-11
	25°	IPD/AA-BR-20	IPD/AA-BR-21



All angled castable abutments include a TPA screw.

Co-Cr 3D BASE / SCAN BODY

Platform				Scan Body
ø3.5	Straight / Angled	IPD/AA-BN-00/3D	IPD/AA-BN-01/3D	IPD/SC-AN-B1
ø4.1	Straight / Angled	IPD/AA-BR-00/3D	IPD/AA-BR-01/3D	IPD/SC-AN-B1



PSD OVERDENTURE ABUTMENT

Platform	Height (mm)	Reference
ø3.5	1.0	IPD/AA-LN-01
	3.0	IPD/AA-LN-03
	5.0	IPD/AA-LN-05
ø4.1	1.0	IPD/AA-LR-01
	2.0	IPD/AA-LR-02
	3.0	IPD/AA-LR-03
	4.0	IPD/AA-LR-04
	5.0	IPD/AA-LR-05





Please see page 208 for the PSD system accessories. >



COMPATIBILITY
CC Series KL™
[ϕ 3.5 / ϕ 4.1 / ϕ 5.1]



TEMPORARY ABUTMENT/ OPEN TRAY COPING

Platform			Coping screw
ϕ 3.5	IPD/AA-PN-06	IPD/AA-PN-07	IPD/AA-TN-00/C
ϕ 4.1	IPD/AA-PR-06	IPD/AA-PR-07	IPD/AA-TR-00/C
ϕ 5.1	IPD/AA-PW-06	IPD/AA-PW-07	IPD/AA-TW-00/C

The same abutment can be used as a temporary abutment with the occlusal screw or as an impression coping using the coping screw.

OPEN AND CLOSED TRAY COPING

Platform		Reference
ϕ 4.1	Open tray coping	IPD/AA-CR-00
	Closed tray coping	IPD/AA-CR-01
ϕ 5.1	Open tray coping	IPD/AA-CW-00



Classic design.

HEALING ABUTMENT

Platform	Height (mm)	Reference
ϕ 3.5	2.0	IPD/AA-DN-02
	3.0	IPD/AA-DN-03
	4.0	IPD/AA-DN-04
ϕ 4.1	2.0	IPD/AA-DR-02
	3.0	IPD/AA-DR-03
	4.0	IPD/AA-DR-04
	5.0	IPD/AA-DR-05
ϕ 5.1	2.0	IPD/AA-DW-02
	3.0	IPD/AA-DW-03
	4.0	IPD/AA-DW-04

STRAIGHT AND ANGLED ABUTMENT

Straight, 15° & 25°

Platform	Height (mm)	Angulation		
ϕ 4.1	1.0	Straight	IPD/AA-PR-00	IPD/AA-PR-01
		15°	IPD/AA-PR-02	-
		25°	IPD/AA-PR-03	-
	2.0	15°	IPD/AA-PR-04	-
		25°	IPD/AA-PR-05	-

Using the low profile IPD/AA-TR-01 screw for IPD/AA-PR-03 is recommended.

CASTABLE

Platform		
ϕ 4.1	IPD/AA-HR-00	IPD/AA-RR-00
ϕ 5.1	IPD/AA-HW-00	IPD/AA-RW-00



Compatibility
KLOCKNER®

CD Series
Vega®
[ϕ 3.5 / ϕ 4.0 / ϕ 4.5]





ANALOG / DIGITAL ANALOG

Platform	Reference	Digital reference
ø3.5	IPD/CD-AN-00	IPD/CD-AN-00/3D
ø4.0 ø4.5	IPD/CD-AR-00	IPD/CD-AR-00/3D
Lower Screw	-	IPD/KA-TA-00
Transverse Screw	-	IPD/KA-TA-01

SCREW

Platform	Screwdriver	Seat	Reference	TiN Reference
ø3.5	Star	Conical	IPD/CD-TN-00	IPD/CD-TN-00/TIN
ø4.0 ø4.5	Star	Conical	IPD/CD-TR-00	IPD/CD-TR-00/TIN



 Lengths 18/25/32 mm. Please see page 225 for more information. >

TPA SCREW FOR ANGLED PROSTHESIS

Platform	Screwdriver	Seat	Reference
ø3.5	TPA	Conical	IPD/CD-TN-50
ø4.0 ø4.5	TPA	Conical	IPD/CD-TR-50



 Lengths 18/25/32 mm. Please see page 226 for more information. >

INTRA-ORAL / DESKTOP / CONTACT PROBE SCAN BODY

Platform	Height (mm)		
ø3.5	10	IPD/CD-SN-00	IPD/CD-SN-01
	15	IPD/CD-SN-02	-
ø4.0 ø4.5	10	IPD/CD-SR-00	IPD/CD-SR-01
	15	IPD/CD-SR-02	-

Captive screw included. 1.20 Hex Screwdriver.

Ti-BASE 

Platform	Height (mm)		
ø3.5	0.7	IPD/CD-IN-00/3D	IPD/CD-IN-01/3D
	1.5	IPD/CD-IN-02/3D	IPD/CD-IN-03/3D
	2.5	IPD/CD-IN-04/3D	IPD/CD-IN-05/3D
ø4.0 ø4.5	0.7	IPD/CD-IR-00/3D	IPD/CD-IR-01/3D
	1.5	IPD/CD-IR-02/3D	IPD/CD-IR-03/3D
	2.5	IPD/CD-IR-04/3D	IPD/CD-IR-05/3D

Please see page 188 for the  accessories. >

STRAIGHT AND ANGLED MULTI-UNIT ABUTMENT



Platform	Height (mm)	Straight	17°	30°
ø3.5	1.5	IPD/CD-MN-01	-	-
	2.5	IPD/CD-MN-02	IPD/CD-MN-12	-
	3.5	IPD/CD-MN-03	-	IPD/CD-MN-33
	4.5	IPD/CD-MN-04	-	-
	5.5	IPD/CD-MN-05	-	-
ø4.0 ø4.5	1.5	IPD/CD-MR-01	-	-
	2.5	IPD/CD-MR-02	IPD/CD-MR-12	-
	3.5	IPD/CD-MR-03	-	IPD/CD-MR-33
	4.5	IPD/CD-MR-04	-	-
	5.5	IPD/CD-MR-05	-	-

Our straight multi-units can be used for single and multiple restorations. Please see page 198 for the Multi-unit system accessories. >



STRAIGHT AND ANGLED CASTABLE ABUTMENT WITH A Co-Cr BASE



Straight, 15° and 25°

Platform	Angulation		
ø3.5	Straight	IPD/CD-BN-00	IPD/CD-BN-01
	15°	IPD/CD-BN-10	IPD/CD-BN-11
	25°	IPD/CD-BN-20	IPD/CD-BN-21
ø4.0 ø4.5	Straight	IPD/CD-BR-00	IPD/CD-BR-01
	15°	IPD/CD-BR-10	IPD/CD-BR-11

All angled castable abutments include a TPA screw.



Co-Cr 3D BASE / SCAN BODY

Platform				Scan Body
ø3.5	Straight / Angled	IPD/CD-BN-00/3D	IPD/CD-BN-01/3D	IPD/SC-AN-B1
ø4.0 ø4.5	Straight / Angled	IPD/CD-BR-00/3D	IPD/CD-BR-01/3D	IPD/SC-AN-B1





COMPATIBILITY
CD Series Vega®
 [ø3.5 / ø4.0 / ø4.5]





PSD OVERDENTURE ABUTMENT

Platform	Height (mm)	Reference
ø3.5	1.0	IPD/CD-LN-01
	2.0	IPD/CD-LN-02
	3.0	IPD/CD-LN-03
	4.0	IPD/CD-LN-04
	5.0	IPD/CD-LN-05
ø4.0 ø4.5	1.0	IPD/CD-LR-01
	2.0	IPD/CD-LR-02
	3.0	IPD/CD-LR-03
	4.0	IPD/CD-LR-04
	5.0	IPD/CD-LR-05

Please see page 208 for the PSD system accessories. >

TEMPORARY ABUTMENT/ OPEN TRAY COPING

Platform			Coping screw
ø3.5	IPD/CD-PN-06	IPD/CD-PN-07	IPD/CD-TN-00/C
ø4.0 ø4.5	IPD/CD-PR-06	IPD/CD-PR-07	IPD/CD-TR-00/C

The same abutment can be used as a temporary abutment with the occlusal screw or as an impression coping using the coping screw.

HEALING ABUTMENT

Platform	Height (mm)	Reference
ø3.5	1.5	IPD/CD-DN-01
	3.0	IPD/CD-DN-03
	5.0	IPD/CD-DN-05
ø4.0 ø4.5	1.5	IPD/CD-DR-01
	3.0	IPD/CD-DR-03
	5.0	IPD/CD-DR-05



Compatibility
STRAUMANN®

DA Series
TISSUE LEVEL
 [ø4.8 RN / ø6.5 WN]

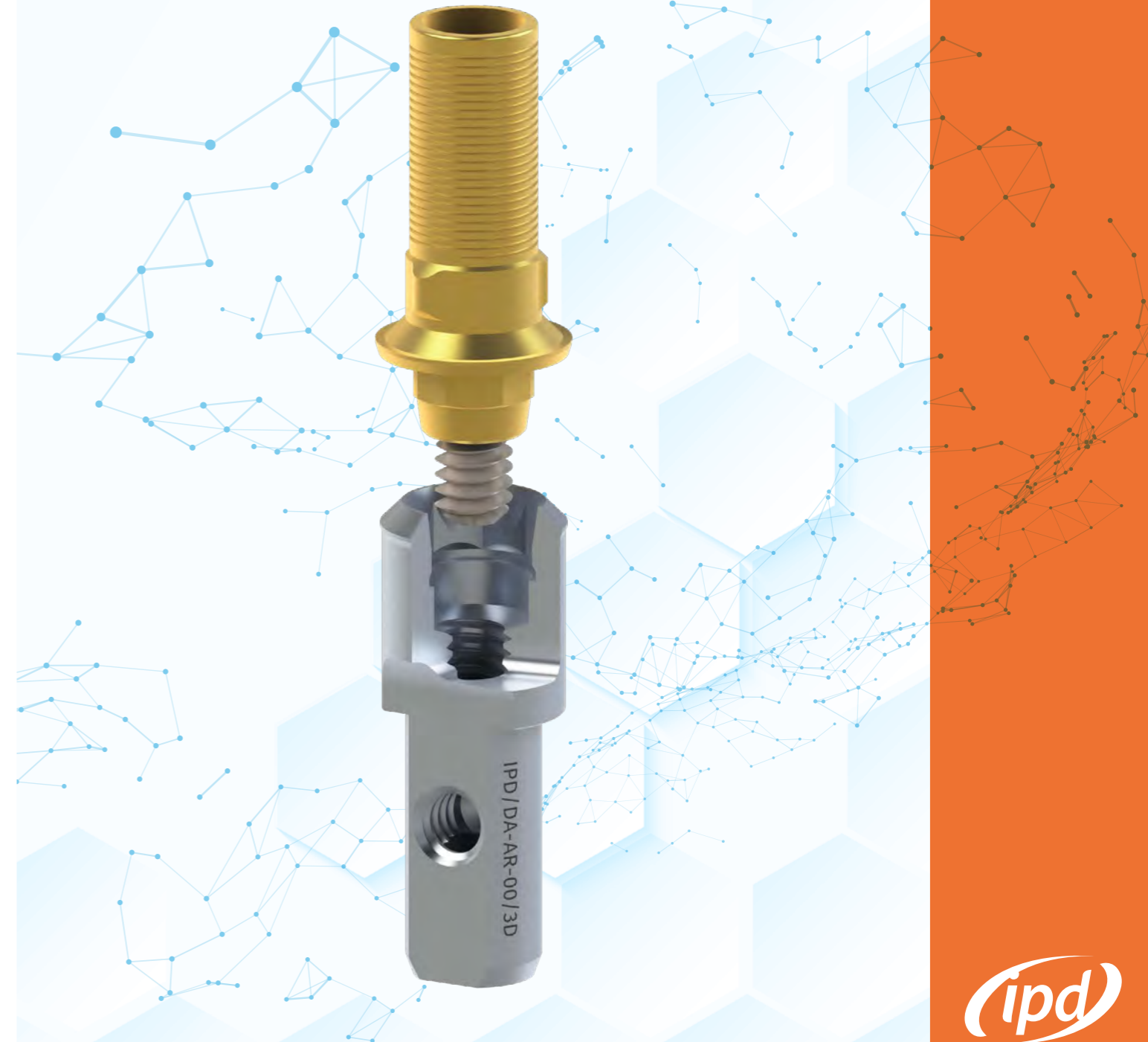



COMPATIBILITY
DA Series TISSUE LEVEL
[ϕ 4.8 RN / ϕ 6.5 WN]



COMPATIBILITY
DA Series TISSUE LEVEL
[ϕ 4.8 RN / ϕ 6.5 WN]



ANALOG / DIGITAL ANALOG

Platform	Reference	Digital reference
ϕ 4.8 RN	IPD/DA-AR-00	IPD/DA-AR-00/3D
	synOcta®	IPD/DA-AR-01
ϕ 6.5 WN	IPD/DA-AW-00	IPD/DA-AW-00/3D
Lower Screw	-	IPD/KA-TA-00
Transverse Screw	-	IPD/KA-TA-01



SCREW

Platform	Screwdriver	Seat	Reference	TiN Reference
ϕ 4.8 RN ϕ 6.5 WN Implant level	Torx	Conical	IPD/DA-TR-01	IPD/DA-TR-01/TIN
	Torx	Flat	IPD/DA-TR-02	-
	Torx	Conical	IPD/DA-TR-03	-
ϕ 4.8 RN synOcta®	Torx	Conical	IPD/DA-TR-00	IPD/DA-TR-00/TIN

The IPD/DA-TR-03 screw has the same measurements as the original direct implant screw.

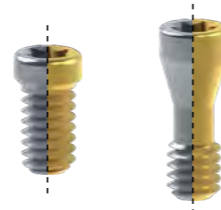
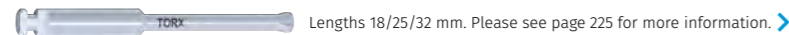

TPA SCREW FOR ANGLED PROSTHESIS

Platform	Screwdriver	Seat	Reference
ϕ 4.8 RN ϕ 6.5 WN	TPA	synOcta® conical	IPD/DA-TR-50
		Implant level conical	IPD/DA-TR-51



INTRA-ORAL / DESKTOP / CONTACT PROBE SCAN BODY

Platform	Height (mm)		
ϕ 4.8 RN	10	IPD/DA-SR-00	IPD/DA-SR-01
	15	IPD/DA-SR-02	-
ϕ 6.5 WN	10	IPD/DA-SW-00	IPD/DA-SW-01

Captive screw included. 1.20 Hex Screwdriver.



Ti-BASE

Platform	Height (mm)		
ϕ 4.8 RN	0.4	IPD/DA-IR-00/3D	IPD/DA-IR-01/3D
ϕ 6.5 WN	1.25	IPD/DA-IW-02/3D	IPD/DA-IW-03/3D

High version of the non-engaging Custom Ti-Base subject to availability. Please see page 188 for the accessories. >



PILAR MULTI-UNIT RECTO

Platform	Height (mm)	Straight
ϕ 4.8 RN	0.9	IPD/DA-MR-01

Our straight multi-units can be used for single and multiple restorations. Please see page 198 for the Multi-unit system accessories. >



STRAIGHT AND ANGLED CASTABLE ABUTMENT WITH A Co-Cr BASE

Straight, 15° & 25°

Platform	Angulation		
ϕ 4.8 RN	Straight	IPD/DA-BR-00	IPD/DA-BR-01
	15°	IPD/DA-BR-10	IPD/DA-BR-11
	25°	IPD/DA-BR-20	IPD/DA-BR-21
ϕ 4.8 RN synOcta®	Straight	IPD/DA-BR-03	IPD/DA-BR-02
	15°	IPD/DA-BR-13	IPD/DA-BR-12
	25°	IPD/DA-BR-23	IPD/DA-BR-22
ϕ 6.5 WN	Straight	IPD/DA-BW-00	IPD/DA-BW-01
	15°	IPD/DA-BW-10	IPD/DA-BW-11
	25°	IPD/DA-BW-20	IPD/DA-BW-21

All angled castable abutments include a TPA screw.



Co-Cr 3D BASE / SCAN BODY

Platform			Scan Body
ϕ 4.8 RN	Straight / Angled	IPD/DA-BR-00/3D	IPD/DA-BR-01/3D
ϕ 4.8 RN synOcta®	Straight / Angled	IPD/DA-BR-03/3D	IPD/DA-BR-02/3D
ϕ 6.5 WN	Straight / Angled	IPD/DA-BW-00/3D	IPD/DA-BW-01/3D



PSD OVERDENTURE ABUTMENT

Platform	Height (mm)	Reference
ϕ 4.8 RN	1.0	IPD/DA-LR-01
	2.0	IPD/DA-LR-02
	3.0	IPD/DA-LR-03

Please see page 208 for the PSD system accessories. >





COMPATIBILITY
DA Series TISSUE LEVEL
[ϕ 4.8 RN / ϕ 6.5 WN]



TEMPORARY ABUTMENT/ OPEN TRAY COPING

Platform			Coping screw
ϕ 4.8 RN		IPD/DA-PR-06	IPD/DA-PR-07
	synOcta®	IPD/DA-PR-09	IPD/DA-PR-08
ϕ 6.5 WN		IPD/DA-PW-06	IPD/DA-PW-07

The same abutment can be used as a temporary abutment with the occlusal screw or as an impression coping using the coping screw.

HEALING ABUTMENT

Platform	Height (mm)	Reference
ϕ 4.8 RN	0.0 Sealing cap	IPD/DA-DR-00
	1.5	IPD/DA-DR-01
	3.0	IPD/DA-DR-03
	4.5	IPD/DA-DR-04

STRAIGHT AND ANGLED ABUTMENT
synOcta® and straight

Platform	Reference
ϕ 4.8 RN	IPD/DA-PR-00
ϕ 6.5 WN	IPD/DA-PR-01
	IPD/DA-PW-00

CASTABLE

Platform		
ϕ 4.8 RN	IPD/DA-HR-01	IPD/DA-RR-01
	synOcta®	IPD/DA-RR-00



Compatibility
STRAUMANN®

DB Series
BONE LEVEL
[ϕ 3.3 NC / ϕ 4.1 RC]





ANALOG / DIGITAL ANALOG

Platform	Reference	Digital reference
ø3.3 NC	IPD/DB-AN-00	IPD/DB-AN-00/3D
ø4.1 RC	IPD/DB-AR-00	IPD/DB-AR-00/3D
Lower Screw	-	IPD/KA-TA-00
Transverse Screw	-	IPD/KA-TA-01



SCREW

Platform	Screwdriver	Seat	Reference	TiN Reference
ø3.3 NC ø4.1 RC	Torx	Conical	IPD/DB-TR-00	IPD/DB-TR-00/TiN

Lengths 18/25/32 mm. Please see page 225 for more information. >



TPA SCREW FOR ANGLED PROSTHESIS

Platform	Screwdriver	Seat	Reference
ø3.3 NC ø4.1 RC	TPA	Conical	IPD/DB-TR-50

Lengths 18/25/32 mm. Please see page 226 for more information. >



INTRA-ORAL / DESKTOP / CONTACT PROBE SCAN BODY

Platform	Height (mm)		
ø3.3 NC	10	IPD/DB-SN-00	IPD/DB-SN-01
	15	IPD/DB-SN-02	-
ø4.1 RC	10	IPD/DB-SR-00	IPD/DB-SR-01
	15	IPD/DB-SR-02	-

Captive screw included. 1.20 Hex Screwdriver.



Ti-BASE

Platform	Height (mm)		
ø3.3 NC	0.5	IPD/DB-IN-00/3D	IPD/DB-IN-01/3D
	1.5	IPD/DB-IN-02/3D	IPD/DB-IN-03/3D
	2.5	IPD/DB-IN-04/3D	IPD/DB-IN-05/3D
	3.5	IPD/DB-IN-06/3D	IPD/DB-IN-07/3D
	0.5	IPD/DB-IR-00/3D	IPD/DB-IR-01/3D
ø4.1 RC	1.5	IPD/DB-IR-02/3D	IPD/DB-IR-03/3D
	2.5	IPD/DB-IR-04/3D	IPD/DB-IR-05/3D
	3.5	IPD/DB-IR-06/3D	IPD/DB-IR-07/3D

High version of the non-engaging Custom Ti-Base subject to availability. Please see page 188 for the accessories. >



STRAIGHT AND ANGLED MULTI-UNIT ABUTMENT

Straight, 17° & 30°

Platform	Height (mm)	Straight	17°	30°
ø3.3 NC	1.5	IPD/DB-MN-01	-	-
	2.5	IPD/DB-MN-02	IPD/DB-MN-12	-
	3.5	IPD/DB-MN-03	IPD/DB-MN-13	IPD/DB-MN-33
	4.5	IPD/DB-MN-04	-	IPD/DB-MN-34
ø4.1 RC	1.5	IPD/DB-MR-01	-	-
	2.5	IPD/DB-MR-02	IPD/DB-MR-12	-
	3.5	IPD/DB-MR-03	IPD/DB-MR-13	IPD/DB-MR-33
	4.5	IPD/DB-MR-04	-	IPD/DB-MR-34

Our straight multi-units can be used for single and multiple restorations. Please see page 198 for the Multi-unit system accessories. >



STRAIGHT AND ANGLED CASTABLE ABUTMENT WITH A Co-Cr BASE

Straight & 15°

Platform	Angulation		
ø3.3 NC	Straight	IPD/DB-BN-00	IPD/DB-BN-01
	15°	IPD/DB-BN-10	IPD/DB-BN-11
ø4.1 RC	Straight	IPD/DB-BR-00	IPD/DB-BR-01
	15°	IPD/DB-BR-10	IPD/DB-BR-11

All angled castable abutments include a TPA screw.



Co-Cr 3D BASE / SCAN BODY

Platform	Angulation			Scan Body
ø3.3 NC	Straight / Angled	IPD/DB-BN-00/3D	IPD/DB-BN-01/3D	IPD/SC-AN-B1
ø4.1 RC	Straight / Angled	IPD/DB-BR-00/3D	IPD/DB-BR-01/3D	IPD/SC-AN-B1



PSD OVERDENTURE ABUTMENT

Platform	Height (mm)	Reference
ø3.3 NC	1.0	IPD/DB-LN-01
	2.0	IPD/DB-LN-02
	3.0	IPD/DB-LN-03
	4.0	IPD/DB-LN-04
	5.0	IPD/DB-LN-05
ø4.1 RC	1.0	IPD/DB-LR-01
	2.0	IPD/DB-LR-02
	4.0	IPD/DB-LR-04
	5.0	IPD/DB-LR-05

Please see page 208 for the PSD system accessories. >







COMPATIBILITY
DB Series BONE LEVEL
[ϕ 3.3 NC / ϕ 4.1 RC]



TEMPORARY ABUTMENT/ OPEN TRAY COPING

Platform			Coping screw
ϕ 3.3 NC	IPD/DB-PN-06	IPD/DB-PN-07	IPD/DB-TR-00/C
ϕ 4.1 RC	IPD/DB-PR-06	IPD/DB-PR-07	IPD/DB-TR-00/C

The same abutment can be used as a temporary abutment with the occlusal screw or as an impression coping using the coping screw.



HEALING ABUTMENT

Platform	Height (mm)	Reference
ϕ 3.3 NC	2.0	IPD/DB-DN-02
	3.5	IPD/DB-DN-03
	5.0	IPD/DB-DN-05
ϕ 4.1 RC	2.0	IPD/DB-DR-02
	4.0	IPD/DB-DR-04
	6.0	IPD/DB-DR-06



STRAIGHT ABUTMENT

Platform	Reference
ϕ 4.1 RC	IPD/DB-PR-00



CASTABLE

Platform		
ϕ 4.1 RC	IPD/DB-HR-00	IPD/DB-RR-00



Compatibility
STRAUMANN®

DC Series
BLX®
RB/WB





ANALOG / DIGITAL ANALOG

Platform	Reference	Digital reference
RB	IPD/DC-AR-00	IPD/DC-AR-00/3D
Lower Screw	-	IPD/KA-TA-00
Transverse Screw	-	IPD/KA-TA-01



SCREW



Platform	Screwdriver	Seat	Reference	TiN Reference
RB/WB	Torx	Conical	IPD/DC-TR-00	IPD/DC-TR-00/TiN
			IPD/DC-TR-01	-

The IPD/DC-TR-01 model is an abutment extractor screw.

 Lengths 18/25/32 mm. Please see page 225 for more information. >





INTRA-ORAL / DESKTOP / CONTACT PROBE SCAN BODY

Platform	Height (mm)		
RB/WB	10	IPD/DC-SR-00	IPD/DC-SR-01
	15	IPD/DC-SR-02	-

Captive screw included. 1.20 Hex Screwdriver.



Ti-BASE

Platform	Height (mm)		
	1.0	IPD/DC-IR-00/3D	IPD/DC-IR-01/3D
RB/WB	2.0	IPD/DC-IR-02/3D	IPD/DC-IR-03/3D
	3.0	IPD/DC-IR-04/3D	IPD/DC-IR-05/3D

Please see page 188 for the  accessories. >



STRAIGHT AND ANGLED MULTI-UNIT ABUTMENT Straight, 17° & 30°

Platform	Height (mm)	Straight	17°	30°
	1.5	IPD/DC-MR-01	-	-
RB/WB	2.5	IPD/DC-MR-02	-	-
	3.5	IPD/DC-MR-03	IPD/DC-MR-13	-
	4.5	-	-	IPD/DC-MR-34

Our straight multi-units can be used for single and multiple restorations. Please see page 198 for the Multi-unit system accessories. >





STRAIGHT CASTABLE ABUTMENT WITH A Co-Cr BASE

Platform	Angulation		
RB/WB	Straight	IPD/DC-BR-00	IPD/DC-BR-01



Co-Cr 3D BASE / SCAN BODY

Platform	Angulation			Scan Body
RB/WB	Straight	IPD/DC-BR-00/3D	IPD/DC-BR-01/3D	IPD/SC-AN-B1



PSD OVERDENTURE ABUTMENT

Platform	Height (mm)	Reference
	2.0	IPD/DC-LR-02
RB/WB	3.0	IPD/DC-LR-03
	4.0	IPD/DC-LR-04

Please see page 208 for the PSD system accessories. >



TEMPORARY ABUTMENT/ OPEN TRAY COPING

Platform			Coping screw
RB/WB	IPD/DC-PR-06	IPD/DC-PR-07	IPD/DC-TR-00/C

The same abutment can be used as a temporary abutment with the occlusal screw or as an impression coping using the coping screw.



HEALING ABUTMENT

Platform	Height (mm)	Reference
	1.5	IPD/DC-DR-01
RB/WB	3.0	IPD/DC-DR-03
	5.0	IPD/DC-DR-05



Compatibility
ASTRA®
EA Series
OSSEOSPEED™
[ϕ 3.0 / ϕ 3.5-4.0 / ϕ 4.5-5.0]

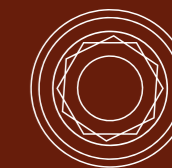

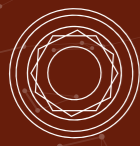

COMPATIBILITY
EA Series OSSEOSPEED™
[ø3.0 / ø3.5-4.0 / ø4.5-5.0]



COMPATIBILITY
EA Series OSSEOSPEED™
[ø3.0 / ø3.5-4.0 / ø4.5-5.0]

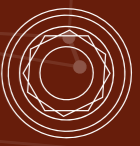

ANALOG / DIGITAL ANALOG

Platform	Reference	Digital reference
ø3.0	IPD/EA-AN-00	IPD/EA-AN-00/3D
ø3.5-4.0	IPD/EA-AR-00	IPD/EA-AR-00/3D
ø4.5-5.0	IPD/EA-AW-00	IPD/EA-AW-00/3D
ø3.5-4.0 / ø4.5-5.0	IPD/EA-AR-01	-
RP - Galimplant® and etk Naturactis® compatible	IPD/EA-AR-02	IPD/EA-AR-02/3D
Lower Screw	-	IPD/KA-TA-00
Transverse Screw	-	IPD/KA-TA-01

IPD/EA-AR-01 is an analogue for the 20° abutment.

SCREW

Platform	Screwdriver	Seat	Reference	TiN Reference
ø3.0	1.27 Hex	Conical	IPD/EA-TN-00	IPD/EA-TN-00/TIN
ø3.5-4.0	1.27 Hex	Flat	IPD/EA-TR-00	IPD/EA-TR-00/TIN
ø4.5-5.0	1.27 Hex	Flat	IPD/EA-TW-00	IPD/EA-TW-00/TIN
ø3.5-4.0 / ø4.5-5.0	1.27 Hex	Flat	IPD/EA-TR-01	IPD/EA-TR-01/TIN

IPD/EA-TR-01 is a screw for the 20° and 45° UniAbutment abutments.

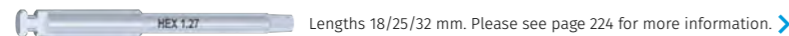

TPA SCREW FOR ANGLED PROSTHESIS

Platform	Screwdriver	Seat	Reference
ø3.0	TPA	Conical	IPD/EA-TN-50
ø3.5-4.0	TPA	Flat	IPD/EA-TR-50
ø4.5-5.0	TPA	Flat	IPD/AC-TR-50 IPD/AC-TR-51
ø3.5-4.0 / ø4.5-5.0	TPA	Flat	IPD/EA-TR-51



IPD/AC-TR-50 is specific for **ipd Custom Interface System®** Ti-Bases.

IPD/AC-TR-51 is specific for angled **ipd Hollow Screw System®** Ti-Bases and IPD 2004 Cr-Co Ti-Bases.

IPD/EA-TR-51 is a screw for the 20° abutment.

INTRA-ORAL / DESKTOP / CONTACT PROBE SCAN BODY

Platform	Height (mm)		
ø3.0	10	IPD/EA-SN-00	IPD/EA-SN-01
	15	IPD/EA-SN-02	-
ø3.5-4.0	10	IPD/EA-SR-00	IPD/EA-SR-01
	15	IPD/EA-SR-02	-
ø4.5-5.0	10	IPD/EA-SW-00	IPD/EA-SW-01
	15	IPD/EA-SW-02	-

Captive screw included. 1.20 Hex Screwdriver.

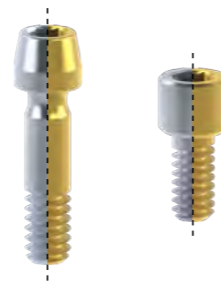

Ti-BASE **ipd Custom Interface System™**

Platform	Height (mm)		
ø3.0	0.8	IPD/EA-IN-00/3D	IPD/EA-IN-01/3D
	1.5	IPD/EA-IN-02/3D	IPD/EA-IN-03/3D
	2.5	IPD/EA-IN-04/3D	IPD/EA-IN-05/3D
ø3.5-4.0	0.5	IPD/EA-IR-00/3D	IPD/EA-IR-01/3D
	1.5	IPD/EA-IR-02/3D	IPD/EA-IR-03/3D
	2.5	IPD/EA-IR-04/3D	IPD/EA-IR-05/3D
ø4.5-5.0	0.5	IPD/EA-IW-00/3D	IPD/EA-IW-01/3D
	1.5	IPD/EA-IW-02/3D	IPD/EA-IW-03/3D

High version of the non-engaging Custom Ti-Base subject to availability. Please see page 188 for the **ipd Custom Interface System®** accessories. >



STRAIGHT AND ANGLED MULTI-UNIT ABUTMENT
Straight, 17° & 30°

Platform	Height (mm)	Straight	17°	30°
ø3.5-4.0	1.5	IPD/EA-MR-01	-	-
	2.5	IPD/EA-MR-02	IPD/EA-MR-12	-
	3.5	IPD/EA-MR-03	IPD/EA-MR-13	IPD/EA-MR-33
	4.5	IPD/EA-MR-04	-	IPD/EA-MR-34
ø4.5-5.0	1.5	IPD/EA-MW-01	-	-
	2.5	IPD/EA-MW-02	IPD/EA-MW-12	-
	3.5	IPD/EA-MW-03	-	IPD/EA-MW-33
	4.5	IPD/EA-MW-04	-	-

Our straight multi-units can be used for single and multiple restorations. Please see page 198 for the Multi-unit system accessories. >



STRAIGHT AND ANGLED CASTABLE ABUTMENT WITH A Co-Cr BASE
Straight, 15° & 25°

Platform	Angulation	Engaging	Rotativo
ø3.0	Straight	IPD/EA-BN-00	IPD/EA-BN-01
	15°	IPD/EA-BN-10	IPD/EA-BN-11
	25°	IPD/EA-BN-20	IPD/EA-BN-21
ø3.5-4.0	Straight	IPD/EA-BR-00	IPD/EA-BR-01
	15°	IPD/EA-BR-10	IPD/EA-BR-11
	25°	IPD/EA-BR-20	IPD/EA-BR-21
ø4.5-5.0	Straight	IPD/EA-BW-00	IPD/EA-BW-01
	15°	IPD/EA-BW-10	IPD/EA-BW-11

All angled castable abutments include a TPA screw.



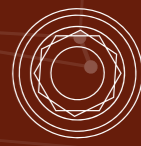
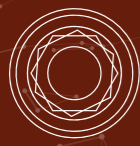

Co-Cr 3D BASE / SCAN BODY

Platform				Scan Body
ø3.0	Straight / Angled	IPD/EA-BN-00/3D	IPD/EA-BN-01/3D	IPD/SC-AN-B1
ø3.5-4.0	Straight / Angled	IPD/EA-BR-00/3D	IPD/EA-BR-01/3D	IPD/SC-AN-B1
ø4.5-5.0	Straight / Angled	IPD/EA-BW-00/3D	IPD/EA-BW-01/3D	IPD/SC-AN-B1



PSD OVERDENTURE ABUTMENT

Platform	Height (mm)	Reference
ø3.5-4.0	1.0	IPD/EA-LR-01
	2.0	IPD/EA-LR-02
	3.0	IPD/EA-LR-03
	4.0	IPD/EA-LR-04
	5.0	IPD/EA-LR-05
ø4.5-5.0	1.0	IPD/EA-LW-01
	2.0	IPD/EA-LW-02
	3.0	IPD/EA-LW-03
	4.0	IPD/EA-LW-04
	5.0	IPD/EA-LW-05



Please see page 208 for the PSD system accessories. >

TEMPORARY ABUTMENT/ OPEN TRAY COPING

Platform			Coping screw
ø3.0	IPD/EA-PN-06	IPD/EA-PN-07	-
ø3.5-4.0	IPD/EA-PR-06	IPD/EA-PR-07	IPD/EA-TR-00/C
ø4.5-5.0	IPD/EA-PW-06	IPD/EA-PW-07	IPD/EA-TW-00/C

The same abutment can be used as a temporary abutment with the occlusal screw or as an impression coping using the coping screw.



OPEN TRAY COPING

Platform	Reference
ø3.0	Open tray coping IPD/EA-CN-00

Classic design.



HEALING ABUTMENT

Platform	Height (mm)	Reference
ø3.5-4.0	2.0	IPD/EA-DR-02
	4.0	IPD/EA-DR-04
	6.0	IPD/EA-DR-06
	8.0	IPD/EA-DR-08
ø4.5-5.0	10.0	IPD/EA-DR-10
	2.0	IPD/EA-DW-02
	4.0	IPD/EA-DW-04
	6.0	IPD/EA-DW-06
	8.0	IPD/EA-DW-08



STRAIGHT ABUTMENT

Platform	Reference
ø3.5-4.0	IPD/EA-PR-00
ø4.5-5.0	IPD/EA-PW-00



CASTABLE

Platform		
ø3.5-4.0	IPD/EA-HR-00	IPD/EA-RR-00
ø4.5-5.0	IPD/EA-HW-00	IPD/EA-RW-00
ø3.5-4.0 / ø4.5-5.0	-	IPD/EA-RR-01

IPD/EA-AR-01 is an analog for 20° angled abutment.



Compatibility
ASTRA®
EB Series
EVOLUTION®
[ϕ 3.6 / ϕ 4.2]

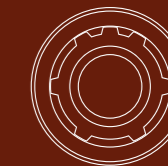



ANALOG / DIGITAL ANALOG

Platform	Reference	Digital reference
ø3.6	IPD/EB-AN-00	IPD/EB-AN-00/3D
ø4.2	IPD/EB-AR-00	IPD/EB-AR-00/3D
Lower Screw	-	IPD/KA-TA-00
Transverse Screw	-	IPD/KA-TA-01



SCREW

Platform	Screwdriver	Seat	Reference	TiN Reference
ø3.6	Hexagonal 1.27	Conical	IPD/EB-TN-00	IPD/EB-TN-00/TIN
ø4.2	Hexagonal 1.27	Conical	IPD/EB-TR-00	IPD/EB-TR-00/TIN

HEX 1.27 Lengths 18/25/32 mm. Please see page 224 for more information. >



TPA SCREW FOR ANGLED PROSTHESIS

Platform	Screwdriver	Seat	Reference
ø3.6	TPA	Conical	IPD/EB-TN-50
ø4.2	TPA	Conical	IPD/EB-TR-50

Lengths 18/25/32 mm. Please see page 226 for more information. >



INTRA-ORAL / DESKTOP / CONTACT PROBE SCAN BODY

Platform	Height (mm)		
ø3.6	10	IPD/EB-SN-00	IPD/EB-SN-01
	15	IPD/EB-SN-02	-
ø4.2	10	IPD/EB-SR-00	IPD/EB-SR-01
	15	IPD/EB-SR-02	-

Captive screw included. 1.20 Hex Screwdriver.



Ti-BASE

Platform	Height (mm)		
ø3.6	0.5	IPD/EB-IN-00/3D	IPD/EB-IN-01/3D
	1.5	IPD/EB-IN-02/3D	IPD/EB-IN-03/3D
	2.5	IPD/EB-IN-04/3D	IPD/EB-IN-05/3D
ø4.2	0.5	IPD/EB-IR-00/3D	IPD/EB-IR-01/3D
	1.5	IPD/EB-IR-02/3D	IPD/EB-IR-03/3D
	2.5	IPD/EB-IR-04/3D	IPD/EB-IR-05/3D

High version of the non-engaging Custom Ti-Base subject to availability. Please see page 188 for the accessories. >



STRAIGHT AND ANGLED MULTI-UNIT ABUTMENT

Straight, 17° & 30°

Platform	Height (mm)	Straight	17°	30°
ø3.6	1.5	IPD/EB-MN-01	-	-
	2.5	IPD/EB-MN-02	IPD/EB-MN-12	-
	3.5	IPD/EB-MN-03	-	IPD/EB-MN-33
ø4.2	1.5	IPD/EB-MR-01	-	-
	2.5	IPD/EB-MR-02	IPD/EB-MR-12	-
	3.5	IPD/EB-MR-03	-	IPD/EB-MR-33

Our straight multi-units can be used for single and multiple restorations. Please see page 198 for the Multi-unit system accessories. >



STRAIGHT AND ANGLED CASTABLE ABUTMENT WITH A Co-Cr BASE

Straight, 15° & 25°

Platform	Angulation		
ø3.6	Straight	IPD/EB-BN-00	IPD/EB-BN-01
	15°	IPD/EB-BN-10	IPD/EB-BN-11
	25°	IPD/EB-BN-20	IPD/EB-BN-21
ø4.2	Straight	IPD/EB-BR-00	IPD/EB-BR-01
	15°	IPD/EB-BR-10	IPD/EB-BR-11

All angled castable abutments include a TPA screw.



Co-Cr 3D BASE / SCAN BODY

Platform			Scan Body
ø3.6	Straight / Angled	IPD/EB-BN-00/3D	IPD/EB-BN-01/3D
ø4.2	Straight / Angled	IPD/EB-BR-00/3D	IPD/EB-BR-01/3D



PSD OVERDENTURE ABUTMENT

Platform	Height (mm)	Reference
ø4.2	1.0	IPD/EB-LR-01
	3.0	IPD/EB-LR-03
	5.0	IPD/EB-LR-05

Please see page 208 for the PSD system accessories. >





COMPATIBILITY
EB Series
[ϕ 3.6 / ϕ 4.2]

EVOLUTION[®]



TEMPORARY ABUTMENT/ OPEN TRAY COPING

Platform			Coping screw
ϕ 3.6	IPD/EB-PN-06	IPD/EB-PN-07	IPD/EB-TN-00/C
ϕ 4.2	IPD/EB-PR-06	IPD/EB-PR-07	IPD/EB-TR-00/C

The same abutment can be used as a temporary abutment with the occlusal screw or as an impression coping using the coping screw.



HEALING ABUTMENT

Platform	Height (mm)	Reference
ϕ 3.6	3.5	IPD/EB-DN-03
	4.5	IPD/EB-DN-04
	5.5	IPD/EB-DN-05
ϕ 4.2	3.5	IPD/EB-DR-03
	4.5	IPD/EB-DR-04
	5.5	IPD/EB-DR-05



Compatibility
ZIMMER[®]

FA Series
SCREW VENT[®]
[ϕ 3.5 / ϕ 4.5 / ϕ 5.7]





ANALOG / DIGITAL ANALOG

Platform	Reference	Digital reference
ϕ 3.5	IPD/FA-AN-00	IPD/FA-AN-00/3D
ϕ 4.5	IPD/FA-AR-00	IPD/FA-AR-00/3D
ϕ 5.7	IPD/FA-AW-00	IPD/FA-AW-00/3D
Lower Screw	-	IPD/KA-TA-00
Transverse Screw	-	IPD/KA-TA-01



SCREW

Platform	Screwdriver	Seat	Reference	TiN Reference
ϕ 3.5 ϕ 4.5 ϕ 5.7	1.25 Hex	Conical	IPD/FA-TR-00	IPD/FA-TR-00/TIN

Lengths 18/25/32 mm. Please see page 224 for more information. >



TPA SCREW FOR ANGLED PROSTHESIS

Platform	Screwdriver	Seat	Reference
ϕ 3.5 ϕ 4.5 ϕ 5.7	TPA	Conical	IPD/FA-TR-50

Lengths 18/25/32 mm. Please see page 226 for more information. >



INTRA-ORAL / DESKTOP / CONTACT PROBE SCAN BODY

Platform	Height (mm)		
ϕ 3.5	10	IPD/FA-SN-00	IPD/FA-SN-01
	15	IPD/FA-SN-02	-
ϕ 4.5	10	IPD/FA-SR-00	IPD/FA-SR-01
	15	IPD/FA-SR-02	-
ϕ 5.7	10	IPD/FA-SW-00	IPD/FA-SW-01
	15	IPD/FA-SW-02	-

Captive screw included. 1.20 Hex Screwdriver.



Ti-BASE

Platform	Height (mm)		
ϕ 3.5	0.5	IPD/FA-IN-00/3D	IPD/FA-IN-01/3D
	1.5	IPD/FA-IN-02/3D	IPD/FA-IN-03/3D
	2.5	IPD/FA-IN-04/3D	IPD/FA-IN-05/3D
ϕ 4.5	0.5	IPD/FA-IR-00/3D	IPD/FA-IR-01/3D
	1.5	IPD/FA-IR-02/3D	IPD/FA-IR-03/3D
	2.5	IPD/FA-IR-04/3D	IPD/FA-IR-05/3D
ϕ 5.7	0.5	IPD/FA-IW-00/3D	IPD/FA-IW-01/3D

High version of the non-engaging Custom Ti-Base subject to availability. Please see page 188 for the accessories. >



STRAIGHT AND ANGLED MULTI-UNIT ABUTMENT

Straight, 17° & 30°

Platform	Height (mm)	Straight	17°	30°
ϕ 3.5	0.9	IPD/FA-MN-00	-	-
	1.5	IPD/FA-MN-01	-	-
	2.5	IPD/FA-MN-02	IPD/FA-MN-12	-
	3.5	IPD/FA-MN-03	IPD/FA-MN-13	IPD/FA-MN-33
ϕ 4.5	4.5	IPD/FA-MN-04	-	IPD/FA-MN-34
	1.5	IPD/FA-MR-01	-	-
	2.5	IPD/FA-MR-02	-	-
	3.0	-	IPD/FA-MR-13	-
	3.5	IPD/FA-MR-03	-	IPD/FA-MR-33
	4.0	-	IPD/FA-MR-14	-
	4.5	IPD/FA-MR-04	-	IPD/FA-MR-34

Our straight multi-units can be used for single and multiple restorations. Please see page 198 for the Multi-unit system accessories. >



STRAIGHT AND ANGLED CASTABLE ABUTMENT WITH A Co-Cr BASE

Straight, 15° & 25°

Platform	Angulation		
ϕ 3.5	Straight	IPD/FA-BN-00	IPD/FA-BN-01
	15°	IPD/FA-BN-10	IPD/FA-BN-11
	25°	IPD/FA-BN-20	IPD/FA-BN-21
ϕ 4.5	Straight	IPD/FA-BR-00	IPD/FA-BR-01
	15°	IPD/FA-BR-10	IPD/FA-BR-11
	25°	IPD/FA-BR-20	IPD/FA-BR-21

All angled castable abutments include a TPA screw.



Co-Cr 3D BASE / SCAN BODY

Platform				Scan Body
ϕ 3.5	Straight / Angled	IPD/FA-BN-00/3D	IPD/FA-BN-01/3D	IPD/SC-AN-B1
ϕ 4.5		IPD/FA-BR-00/3D	IPD/FA-BR-01/3D	IPD/SC-AN-B1
	Angled	IPD/FA-BR-A0/3D	IPD/FA-BR-A1/3D	IPD/SC-AN-B1



PSD OVERDENTURE ABUTMENT

Platform	Height (mm)	Reference
ϕ 3.5	1.0	IPD/FA-LN-01
	2.0	IPD/FA-LN-02
	3.0	IPD/FA-LN-03
	4.0	IPD/FA-LN-04
	5.0	IPD/FA-LN-05
ϕ 4.5	1.0	IPD/FA-LR-01
	2.0	IPD/FA-LR-02
	3.0	IPD/FA-LR-03
	4.0	IPD/FA-LR-04
	5.0	IPD/FA-LR-05

Please see page 208 for the PSD system accessories. >







COMPATIBILITY
FA Series SCREW VENT®
 [ø3.5 / ø4.5 / ø5.7]



TEMPORARY ABUTMENT/ OPEN TRAY COPING

Platform			Coping screw
ø3.5	IPD/FA-PN-06	IPD/FA-PN-07	IPD/FA-TR-00/C
ø4.5	IPD/FA-PR-06	IPD/FA-PR-07	IPD/FA-TR-00/C
ø5.7	IPD/FA-PW-06	IPD/FA-PW-07	IPD/FA-TR-00/C

The same abutment can be used as a temporary abutment with the occlusal screw or as an impression coping using the coping screw.

OPEN TRAY COPING

Platform		Reference
ø3.5	Open tray coping	IPD/FA-CN-00
ø5.7	Open tray coping	IPD/FA-CW-00

Classic design.

HEALING ABUTMENT



Platform	Height (mm)	Reference
ø3.5	1.5	IPD/FA-DN-01
	3.0	IPD/FA-DN-03
	5.0	IPD/FA-DN-05
ø4.5	1.5	IPD/FA-DR-01
	3.0	IPD/FA-DR-03
	5.0	IPD/FA-DR-05

STRAIGHT AND ANGLED ABUTMENT

Straight, 15° & 25°

Platform	Height (mm)	Angulation	Reference
ø3.5	1.0	Straight	IPD/FA-PN-00
		15°	IPD/FA-PN-02
		25°	IPD/FA-PN-04
	2.0	Straight	IPD/FA-PN-01
		15°	IPD/FA-PN-03
		25°	IPD/FA-PN-05

CASTABLE

Platform		
ø3.5	IPD/FA-HN-00	IPD/FA-RN-00
ø4.5	IPD/FA-HR-00	IPD/FA-RR-00
ø5.7	IPD/FA-HW-00	IPD/FA-RW-00



Compatibility
ZIMMER®

FB Series SWISSPLUS®
 [ø4.8]





ANALOG / DIGITAL ANALOG

Platform	Reference	Digital reference
ø4.8	IPD/DA-AR-00	IPD/DA-AR-00/3D
Lower Screw	-	IPD/KA-TA-00
Transverse Screw	-	IPD/KA-TA-01



SCREW

Platform	Screwdriver	Seat	Reference	TiN Reference
ø4.8	Torx	synOcta® conical	IPD/DA-TR-00	IPD/DA-TR-00/TIN
	1.25 Hex	Conical	IPD/FB-TR-00	IPD/FB-TR-00/TIN
		Conical	IPD/FB-TR-01	IPD/FB-TR-01/TIN

IPD/FB-TR-00 and /TIN are exclusive implant level screws for original SWISSPLUS® abutments.
IPD/FB-TR-01 and /TIN are implant level screws compatible for use with IPD abutments.

Lengths 18/25/32 mm. Please see page 225 for more information. >

Lengths 18/25/32 mm. Please see page 224 for more information. >

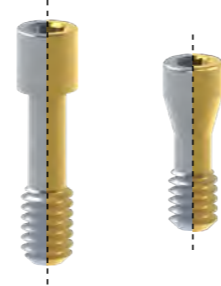

TPA SCREW FOR ANGLED PROSTHESIS

Platform	Screwdriver	Seat	Reference
ø4.8	TPA	synOcta® conical	IPD/DA-TR-50
		Implant level conical	IPD/DA-TR-51

Lengths 18/25/32 mm. Please see page 226 for more information. >



INTRA-ORAL / DESKTOP / CONTACT PROBE SCAN BODY

Platform	Height (mm)		
ø4.8	10	IPD/DA-SR-00	IPD/DA-SR-01
	15	IPD/DA-SR-02	-

Captive screw included. 1.20 Hex Screwdriver.



Ti-BASE

Platform	Height (mm)		
ø4.8	0.8	IPD/DA-IR-00/3D	IPD/DA-IR-01/3D

High version of the non-engaging Custom Ti-Base subject to availability.
Please see page 188 for the accessories. >



STRAIGHT MULTI-UNIT ABUTMENT

Platform	Height (mm)	Straight
ø4.8	0.9	IPD/DA-MR-01

Our straight multi-units can be used for single and multiple restorations.
Please see page 198 for the Multi-unit system accessories. >



STRAIGHT AND ANGLED CASTABLE ABUTMENT WITH A Co-Cr BASE

Straight, 15° & 25°

Platform	Angulation		
ø4.8	Straight	IPD/DA-BR-00	IPD/DA-BR-01
		synOcta® IPD/DA-BR-03	IPD/DA-BR-02
	15°	IPD/DA-BR-10	IPD/DA-BR-11
		synOcta® IPD/DA-BR-13	IPD/DA-BR-12
	25°	IPD/DA-BR-20	IPD/DA-BR-21

All angled castable abutments include a TPA screw.



Co-Cr 3D BASE / SCAN BODY

Platform			Scan Body
ø4.8	Straight / Angled	IPD/DA-BR-00/3D	IPD/DA-BR-01/3D
ø4.8 synOcta®	Straight / Angled	IPD/DA-BR-03/3D	IPD/DA-BR-02/3D
			IPD/SC-AN-B2



PSD OVERDENTURE ABUTMENT

Platform	Height (mm)	Reference
ø4.8	1.0	IPD/DA-LR-01
	2.0	IPD/DA-LR-02
	3.0	IPD/DA-LR-03

Please see page 208 for the PSD system accessories. >



TEMPORARY ABUTMENT/ OPEN TRAY COPING

Platform			Coping screw
ø4.8	IPD/DA-PR-06	IPD/DA-PR-07	IPD/DA-TR-01/C
	synOcta® IPD/DA-PR-09	IPD/DA-PR-08	IPD/DA-TR-00/C

The same abutment can be used as a temporary abutment with the occlusal screw or as an impression coping using the coping screw.





COMPATIBILITY
FB Series **SWISSPLUS®**
[ϕ 4.8]



HEALING ABUTMENT

Platform	Height (mm)	Reference
ϕ 4.8	Sealing cap	IPD/DA-DR-00
	1.5	IPD/DA-DR-01
	3.0	IPD/DA-DR-03
	4.5	IPD/DA-DR-04





STRAIGHT ABUTMENT

Platform	Reference
ϕ 4.8	IPD/DA-PR-01
	synOcta® IPD/DA-PR-00



CASTABLE

Platform		
ϕ 4.8	IPD/DA-HR-01	IPD/DA-RR-01
	synOcta® IPD/DA-HR-00	IPD/DA-RR-00



Compatibility
ZIMMER®
FC Series
EZTETIC®
[ϕ 3.1]





ANALOG / DIGITAL ANALOG

Platform	Reference	Digital reference
ø3.1	IPD/FC-AT-00	IPD/FC-AT-00/3D
Lower Screw	-	IPD/KA-TA-00
Transverse Screw	-	IPD/KA-TA-01



SCREW

Platform	Screwdriver	Seat	Reference	TiN Reference
ø3.1	1.25 Hex	Conical	IPD/FC-TT-00	IPD/FC-TT-00/TiN



TPA SCREW FOR ANGLED PROSTHESIS

Platform	Screwdriver	Seat	Reference
ø3.1	TPA	Conical	IPD/FC-TT-50

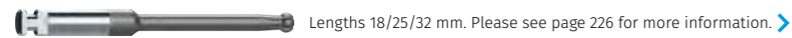

INTRA-ORAL / DESKTOP / CONTACT PROBE SCAN BODY

Platform	Height (mm)		
ø3.1	10	IPD/FC-ST-00	IPD/FC-ST-01
	15	IPD/FC-ST-02	-

Captive screw included. 1.20 Hex Screwdriver.



Ti-BASE

Platform	Height (mm)		
ø3.1	1.0	IPD/FC-IT-00/3D	IPD/FC-IT-01/3D
	2.0	IPD/FC-IT-02/3D	IPD/FC-IT-03/3D
	3.0	IPD/FC-IT-04/3D	IPD/FC-IT-05/3D

Please see page 188 for the accessories. >



STRAIGHT AND ANGLED MULTI-UNIT ABUTMENT

Straight, 17° & 30°

Platform	Height (mm)	Straight	17°	30°
ø3.1	1.5	IPD/FC-MT-01	-	-
	2.5	IPD/FC-MT-02	IPD/FC-MT-12	-
	3.5	IPD/FC-MT-03	-	IPD/FC-MT-33

Our straight multi-units can be used for single and multiple restorations. Please see page 198 for the Multi-unit system accessories. >



STRAIGHT AND ANGLED CASTABLE ABUTMENT WITH A Co-Cr BASE

Straight & 15°

Platform	Angulation		
ø3.1	Straight	IPD/FC-BT-00	IPD/FC-BT-01
	15°	IPD/FC-BT-10	IPD/FC-BT-11



Co-Cr 3D BASE / SCAN BODY

Platform			Scan Body
ø3.1	Straight / Angled	IPD/FC-BT-00/3D	IPD/FC-BT-01/3D



PSD OVERDENTURE ABUTMENT

Platform	Height (mm)	Reference
ø3.1	2.0	IPD/FC-LT-02
	3.0	IPD/FC-LT-03
	4.0	IPD/FC-LT-04

Please see page 208 for the PSD system accessories. >



TEMPORARY ABUTMENT/ OPEN TRAY COPING

Platform			Coping screw
ø3.1	IPD/FC-PT-06	IPD/FC-PT-07	IPD/FC-TT-00/C

The same abutment can be used as a temporary abutment with the occlusal screw or as an impression coping using the coping screw.



HEALING ABUTMENT

Platform	Height (mm)	Straight
ø3.1	1.0	IPD/FC-DT-01
	2.5	IPD/FC-DT-02
	4.0	IPD/FC-DT-04



Compatibility
BTI®
GA Series
EXTERNAL
[ϕ 3.5 / ϕ 4.1 / ϕ 5.5]





ANALOG / DIGITAL ANALOG

Platform	Reference	Digital reference
ϕ 3.5 Tiny®	IPD/GA-AN-00	IPD/GA-AN-00/3D
ϕ 4.1	IPD/AA-AR-00	IPD/AA-AR-00/3D
ϕ 5.5	IPD/GA-AW-00	-
Lower Screw	-	IPD/KA-TA-00
Transverse Screw	-	IPD/KA-TA-01

SCREW

Platform	Screwdriver	Seat	Reference	TiN Reference
ϕ 3.5 Tiny®	1.20 Hex	Flat	IPD/GA-TN-00	IPD/GA-TN-00/TiN
ϕ 4.1	1.20 Hex	Conical	IPD/BA-TR-00	IPD/BA-TR-00/TiN
ϕ 5.5	1.20 Hex	Flat	IPD/GA-TW-00	IPD/GA-TW-00/TiN



 HEX 1.20 Lengths 18/25/32 mm. Please see page 224 for more information. >

TPA SCREW FOR ANGLED PROSTHESIS

Platform	Screwdriver	Seat	Reference
ϕ 3.5 Tiny®	TPA	Flat	IPD/GA-TN-50
ϕ 4.1 ϕ 5.5	TPA	Conical	IPD/AA-TR-50
	TPA	Flat	IPD/AA-TR-52



 Lengths 18/25/32 mm. Please see page 226 for more information. >

INTRA-ORAL / DESKTOP / CONTACT PROBE SCAN BODY

Platform	Height (mm)		
ϕ 3.5 Tiny®	10	IPD/GA-SN-00	IPD/GA-SN-01
	15	IPD/GA-SN-02	-
ϕ 4.1	10	IPD/AA-SR-00	IPD/AA-SR-01
	15	IPD/AA-SR-02	-

Captive screw included. 1.20 Hex Screwdriver.

Ti-BASE

Platform	Height (mm)		
ϕ 3.5 Tiny®	1.5	IPD/GA-IN-02/3D	IPD/GA-IN-03/3D
	0.5	IPD/AA-IR-00/3D	IPD/AA-IR-01/3D
ϕ 4.1	1.5	IPD/AA-IR-02/3D	IPD/AA-IR-03/3D
	2.5	IPD/AA-IR-04/3D	IPD/AA-IR-05/3D

High version of the non-engaging Custom Ti-Base subject to availability. Please see page 188 for the  accessories. >

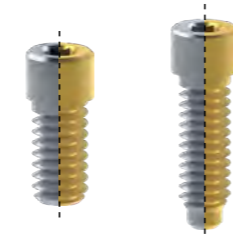

STRAIGHT AND ANGLED MULTI-UNIT ABUTMENT Straight, 17° & 30°

Platform	Height (mm)	Straight	17°	30°
ϕ 4.1	1.0	IPD/AB-MR-01	-	-
	2.0	IPD/AB-MR-02	IPD/AB-MR-12	-
	3.0	IPD/AB-MR-03	IPD/AB-MR-13	IPD/AB-MR-33
	4.0	IPD/AB-MR-04	IPD/AB-MR-14	IPD/AB-MR-34
	5.0	IPD/AB-MR-05	-	IPD/AB-MR-35

Our straight multi-units can be used for single and multiple restorations. Please see page 198 for the Multi-unit system accessories. >





STRAIGHT AND ANGLED CASTABLE ABUTMENT WITH A Co-Cr BASE Straight, 15° & 25°

Platform	Angulation		
ϕ 3.5 Tiny®	Straight	IPD/GA-BN-00	IPD/GA-BN-01
	15°	IPD/GA-BN-10	IPD/GA-BN-11
	25°	IPD/GA-BN-20	IPD/GA-BN-21
ϕ 4.1	Straight	IPD/AA-BR-00	IPD/AA-BR-01
	15°	IPD/AA-BR-10	IPD/AA-BR-11
	25°	IPD/AA-BR-20	IPD/AA-BR-21

All angled castable abutments include a TPA screw.



Co-Cr 3D BASE / SCAN BODY

Platform				Scan Body
ϕ 3.5 Tiny®	Straight / Angled	IPD/GA-BN-00/3D	IPD/GA-BN-01/3D	IPD/SC-AN-B1
ϕ 4.1	Straight / Angled	IPD/AA-BR-00/3D	IPD/AA-BR-01/3D	IPD/SC-AN-B1



PSD OVERDENTURE ABUTMENT

Platform	Height (mm)	Reference
ϕ 4.1	1.0	IPD/AA-LR-01
	2.0	IPD/AA-LR-02
	3.0	IPD/AA-LR-03
	4.0	IPD/AA-LR-04
	5.0	IPD/AA-LR-05

Please see page 208 for the PSD system accessories. >





COMPATIBILITY GA Series EXTERNAL [ϕ 3.5 / ϕ 4.1 / ϕ 5.5]



TEMPORARY ABUTMENT/ OPEN TRAY COPING

Platform			Coping screw
ϕ 4.1	IPD/AA-PR-06	IPD/AA-PR-07	IPD/AA-TR-00/C

The same abutment can be used as a temporary abutment with the occlusal screw or as an impression coping using the coping screw.

OPEN AND CLOSED TRAY COPING

Platform		Reference
ϕ 3.5 Tiny®	Open tray coping	IPD/GA-CN-00
ϕ 4.1	Open tray coping	IPD/AA-CR-00
	Closed tray coping	IPD/AA-CR-01

Classic design.

HEALING ABUTMENT

Platform	Height (mm)	Reference
ϕ 3.5 Tiny®	4.0	IPD/GA-DN-04
	2.0	IPD/AA-DR-02
ϕ 4.1	3.0	IPD/AA-DR-03
	4.0	IPD/AA-DR-04
	5.0	IPD/AA-DR-05

STRAIGHT AND ANGLED ABUTMENT Straight, 15° & 25°

Platform	Height (mm)	Angulation		
ϕ 3.5 Tiny®		Straight	IPD/GA-PN-00	-
		Straight	IPD/AA-PR-00	IPD/AA-PR-01
ϕ 4.1	1.0	15°	IPD/AA-PR-02	-
		25°	IPD/AA-PR-03	-
	2.0	15°	IPD/AA-PR-04	-
		25°	IPD/AA-PR-05	-
ϕ 5.5		Straight	IPD/GA-PW-00	-
		Straight	IPD/GA-PW-01	-

The IPD/GA-PW-01 model has a broader shoulder than the IPD/GA-PW-00.
Using the low profile IPD/AA-TR-01 screw for IPD/AA-PR-03 is recommended.

CASTABLE

Platform		
ϕ 4.1	IPD/AA-HR-00	IPD/AA-RR-00
ϕ 5.5	IPD/GA-HW-00	IPD/GA-RW-00



Compatibility BTI® GB Series INTERNAL UNIVERSAL® [Universal® ϕ 4.1 / Wide ϕ 5.5]

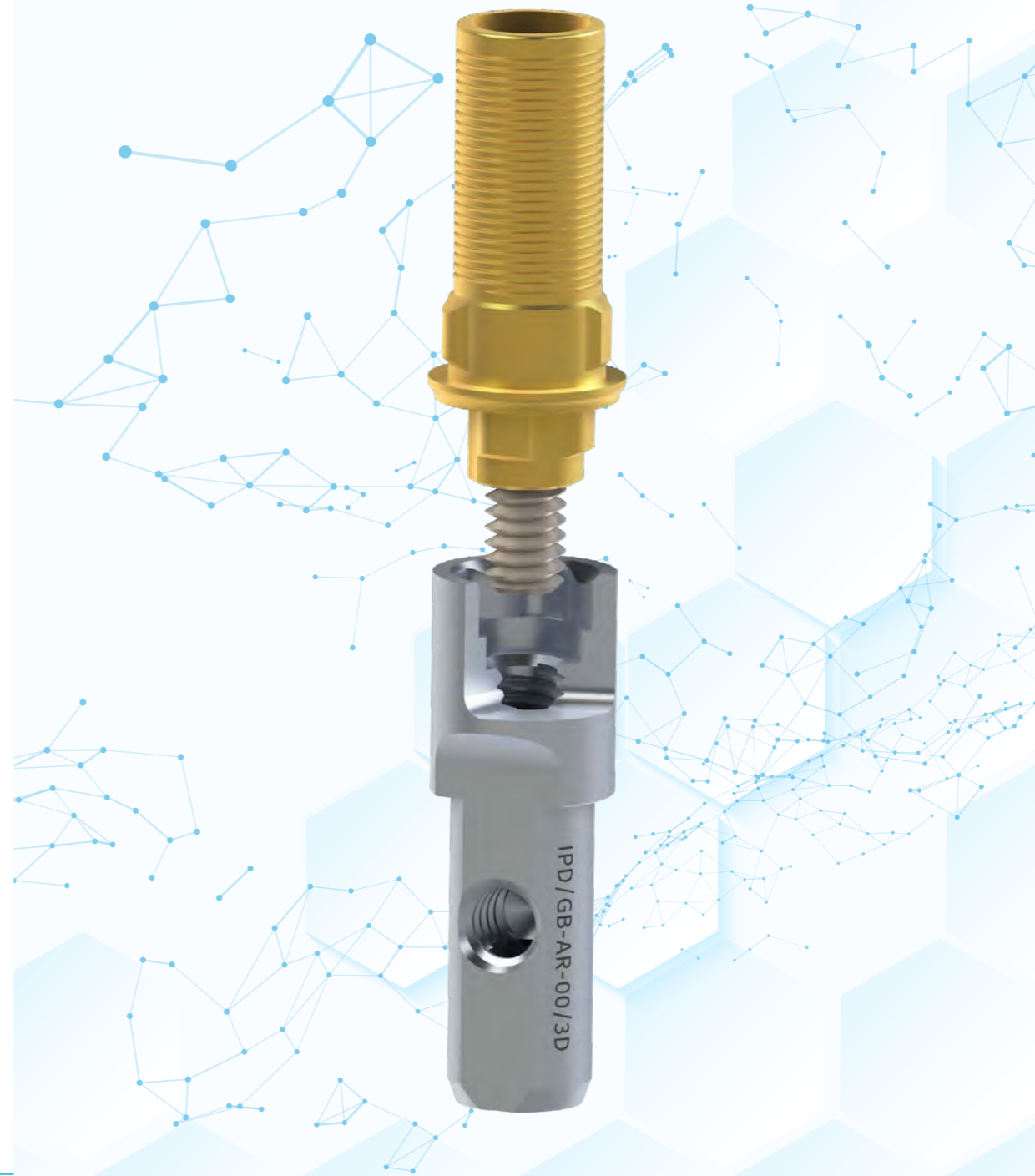



ANALOG / DIGITAL ANALOG

Platform	Reference	Digital reference
ø4.1	IPD/GB-AR-00	IPD/GB-AR-00/3D
ø5.5	IPD/GB-AW-00	-
Lower Screw	-	IPD/KA-TA-00
Transverse Screw	-	IPD/KA-TA-01



STRAIGHT AND ANGLED MULTI-UNIT ABUTMENT

Straight, 17° & 30°

Platform	Height (mm)	Straight	17°	30°
ø4.1	1.0	IPD/GB-MR-01	-	-
	2.0	IPD/GB-MR-02	-	-
	3.0	IPD/GB-MR-03	IPD/GB-MR-13	-
	4.0	IPD/GB-MR-04	IPD/GB-MR-14	IPD/GB-MR-34
	5.0	IPD/GB-MR-05	-	IPD/GB-MR-35



Our straight multi-units can be used for single and multiple restorations. Please see page 198 for the Multi-unit system accessories. >

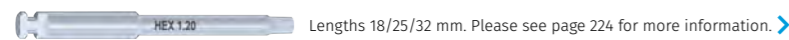

SCREW

Platform	Screwdriver	Seat	Reference	TiN Reference
ø4.1 ø5.5	1.20 Hex	Flat	IPD/GB-TR-00	IPD/GB-TR-00/TIN



STRAIGHT AND ANGLED CASTABLE ABUTMENT WITH A Co-Cr BASE

Straight, 15° & 25°

Platform	Angulation		
ø4.1	Straight	IPD/GB-BR-00	IPD/GB-BR-01
	15°	IPD/GB-BR-10	IPD/GB-BR-11
	25°	IPD/GB-BR-20	IPD/GB-BR-21



All angled castable abutments include a TPA screw.

TPA SCREW FOR ANGLED PROSTHESIS

Platform	Screwdriver	Seat	Reference
ø4.1 ø5.5	TPA	Flat	IPD/GB-TR-50

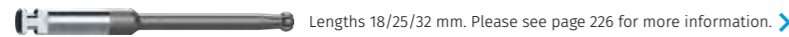



Co-Cr 3D BASE / SCAN BODY

Platform				Scan Body
ø4.1	Straight / Angled	IPD/GB-BR-00/3D	IPD/GB-BR-01/3D	IPD/SC-AN-B1



INTRA-ORAL / DESKTOP / CONTACT PROBE SCAN BODY

Platform	Height (mm)		
ø4.1	10	IPD/GB-SR-00	IPD/GB-SR-01
	15	IPD/GB-SR-02	-

Captive screw included. 1.20 Hex Screwdriver.





PSD OVERDENTURE ABUTMENT

Platform	Height (mm)	Reference
ø4.1	1.0	IPD/GB-LR-01
	3.0	IPD/GB-LR-03
	5.0	IPD/GB-LR-05



Please see page 208 for the PSD system accessories. >

Ti-BASE 

Platform	Height (mm)		
ø4.1	0.5	IPD/GB-IR-00/3D	IPD/GB-IR-01/3D
	1.5	IPD/GB-IR-02/3D	IPD/GB-IR-03/3D
	2.5	IPD/GB-IR-04/3D	IPD/GB-IR-05/3D

High version of the non-engaging Custom Ti-Base subject to availability. Please see page 188 for the  accessories. >





COMPATIBILITY

GB Series INTERNAL UNIVERSAL®

[Universal® ø4.1 / Wide ø5.5]



TEMPORARY ABUTMENT/ OPEN TRAY COPING

Platform			Coping screw
ø4.1	IPD/GB-PR-06	IPD/GB-PR-07	IPD/GB-TR-00/C

The same abutment can be used as a temporary abutment with the occlusal screw or as an impression coping using the coping screw.



HEALING ABUTMENT

Platform	Height (mm)	Reference
ø4.1	1.0	IPD/GB-DR-01
	3.0	IPD/GB-DR-03
	5.0	IPD/GB-DR-05

CASTABLE

Platform		
ø4.1	IPD/GB-HR-00	IPD/GB-RR-00
ø5.5	-	IPD/GB-RW-00

Compatibility

BTI®

GC Series

MULTI-IM®

[ø4.1]





ANALOG / DIGITAL ANALOG

Platform	Reference	Digital reference
Ø4.1	IPD/GC-AR-00	IPD/GC-AR-00/3D
Lower Screw	-	IPD/KA-TA-00
Transverse Screw	-	IPD/KA-TA-01



SCREW

Platform	Screwdriver	Seat	Reference	TiN Reference
Ø4.1	1.20 Hex	Flat	IPD/GC-TR-01	IPD/GC-TR-01/TiN

 HEX 1.20 Lengths 18/25/32 mm. Please see page 224 for more information. >



TPA SCREW FOR ANGLED PROSTHESIS

Platform	Screwdriver	Seat	Reference
Ø4.1	TPA	Flat	IPD/AB-TR-50

 Lengths 18/25/32 mm. Please see page 226 for more information. >



INTRA-ORAL / DESKTOP / CONTACT PROBE SCAN BODY

Platform	Height (mm)	Reference
Ø4.1	10	IPD/GC-SR-01

Captive screw included. 1.20 Hex Screwdriver.



Ti-BASE 

Platform	Height (mm)	Reference
Ø4.5	0.3	IPD/GC-IR-01/3D

Please see page 188 for the  accessories. >



STRAIGHT AND ANGLED CASTABLE ABUTMENT WITH A Co-Cr BASE
Straight, 15° & 25°

Platform	Angulation	Reference
Ø4.1	Straight	IPD/GC-BR-01
	15°	IPD/GC-BR-11
	25°	IPD/GC-BR-21

All angled castable abutments include a TPA screw.



Co-Cr 3D BASE / SCAN BODY

Platform	Scan Body	Reference
Ø4.1	Straight / Angled	IPD/GC-BR-01/3D IPD/SC-AN-B2



TEMPORARY ABUTMENT/ OPEN TRAY COPING

Platform	Coping screw	Reference
Ø4.1	IPD/GC-PR-07 IPD/GC-TR-01/C	

The same abutment can be used as a temporary abutment with the occlusal screw or as an impression coping using the coping screw.



HEALING ABUTMENT

Platform	Reference
Ø4.1	IPD/GC-DN-00



Compatibility
MICRODENT®

HA Series
MICRODENT® SYSTEM
[ϕ 3.5 / ϕ 4.2 / ϕ 5.1]

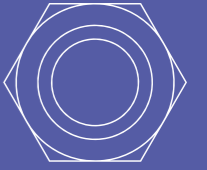

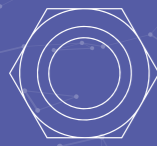

COMPATIBILITY HA Series MICRODENT® SYSTEM [Ø3.5 / Ø4.2 / Ø5.1]

ANALOG

Platform	Reference
Ø3.5	IPD/HA-AN-00
Ø4.2	IPD/HA-AR-00
Ø5.1	IPD/HA-AW-00

SCREW

Platform	Screwdriver	Seat	Reference	TiN Reference
Ø3.5	1.20 Hex	Conical	IPD/HA-TN-00	IPD/HA-TN-00/TIN
Ø4.2 Ø5.1	1.75 Hex	Conical	IPD/HA-TR-00	IPD/HA-TR-00/TIN
Ø5.1	1.25 Hex	Conical	IPD/NA-TW-00	-

 HEX 1.20 Lengths 18/25/32 mm. Please see page 224 for more information. >

TPA SCREW FOR ANGLED PROSTHESIS

Platform	Screwdriver	Seat	Reference
Ø3.5	TPA	Conical	IPD/HA-TN-50
Ø4.2 Ø5.1	TPA	Conical	IPD/HA-TR-50
Ø5.1	TPA	Conical	IPD/MB-TR-50

 Lengths 18/25/32 mm. Please see page 226 for more information. >

SCAN BODY / Ti-BASE

Platform			
Ø5.1	Scan body	IPD/NA-SW-00	IPD/NA-SW-01
	Ti-Base	IPD/NA-IW-02/3D	IPD/NA-IW-03/3D

Please see page 188 for the  accessories. >



For the Ti-Base it is recommended to use the screw IPD/NA-TW-00 or the IPD/MB-TR-50 for angled solutions.

TEMPORARY ABUTMENT / OPEN TRAY COPING

Platform			Coping screw
Ø5.1	IPD/NA-PW-06	IPD/NA-PW-07	IPD/NA-TW-00/C

The same abutment can be used as a temporary abutment with the occlusal screw or as an impression coping using the coping screw.

CASTABLE

Platform		
Ø4.1	IPD/HA-HN-00	IPD/HA-RN-00
Ø4.2	IPD/HA-HR-00	IPD/HA-RR-00
Ø5.1	IPD/HA-HW-00	IPD/HA-RW-00



Compatibility MICRODENT® HB Series MICRODENT® UNIVERSAL™ [Ø3.5 / Ø4.1 / Ø5.1]





COMPATIBILITY

HB Series MICRODENT® UNIVERSAL™
[ø3.5 / ø4.1 / ø5.1]



HB Series MICRODENT® UNIVERSAL™
[ø3.5 / ø4.1 / ø5.1]



ANALOG / DIGITAL ANALOG

Platform	Reference	Digital reference
ø3.5	IPD/HA-AN-00	-
ø4.1	IPD/AA-AR-00	IPD/AA-AR-00/3D
ø5.1	IPD/BA-AW-00	IPD/BA-AW-00/3D
Lower Screw	-	IPD/KA-TA-00
Transverse Screw	-	IPD/KA-TA-01



STRAIGHT AND ANGLED MULTI-UNIT ABUTMENT

Platform	Height (mm)	Straight	17°	30°
ø4.1	1.0	IPD/AB-MR-01	-	-
	2.0	IPD/AB-MR-02	IPD/AB-MR-12	-
	3.0	IPD/AB-MR-03	IPD/AB-MR-13	IPD/AB-MR-33
	4.0	IPD/AB-MR-04	IPD/AB-MR-14	IPD/AB-MR-34
	5.0	IPD/AB-MR-05	-	IPD/AB-MR-35



Our straight multi-units can be used for single and multiple restorations. Please see page 198 for the Multi-unit system accessories. >

SCREW

Platform	Screwdriver	Seat	Reference	TiN Reference
ø3.5	1.20 Hex	Conical	IPD/HA-TN-00	IPD/HA-TN-00/TIN
ø4.1 ø5.1	1.20 Hex	Conical	IPD/BA-TR-00	IPD/BA-TR-00/TIN
	1.20 Hex	Low profile conical	IPD/AA-TR-01	IPD/AA-TR-01/TIN

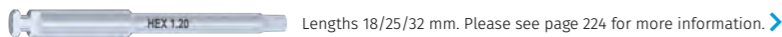

STRAIGHT AND ANGLED CASTABLE ABUTMENT WITH A Co-Cr BASE Straight, 15° & 25°

Platform	Angulation		
ø4.1	Straight	IPD/AA-BR-00	IPD/AA-BR-01
	15°	IPD/AA-BR-10	IPD/AA-BR-11
	25°	IPD/AA-BR-20	IPD/AA-BR-21
ø5.1	Straight	IPD/BA-BW-00	IPD/BA-BW-01
	15°	IPD/BA-BW-10	IPD/BA-BW-11
	25°	IPD/BA-BW-20	IPD/BA-BW-21



All angled castable abutments include a TPA screw.

TPA SCREW FOR ANGLED PROSTHESIS

Platform	Screwdriver	Seat	Reference
ø3.5	TPA	Conical	IPD/HA-TN-50
ø4.1 ø5.1	TPA	Conical	IPD/AA-TR-50
	TPA	Flat seat	IPD/AA-TR-52

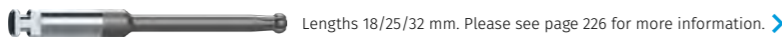

Co-Cr 3D BASE / SCAN BODY

Platform				Scan Body
ø4.1	Straight / Angled	IPD/AA-BR-00/3D	IPD/AA-BR-01/3D	IPD/SC-AN-B1
ø5.1	Straight / Angled	IPD/BA-BW-00/3D	IPD/BA-BW-01/3D	IPD/SC-AN-B1



INTRA-ORAL / DESKTOP / CONTACT PROBE SCAN BODY

Platform	Height (mm)		
ø4.1	10	IPD/AA-SR-00	IPD/AA-SR-01
	15	IPD/AA-SR-02	-
ø5.1	10	IPD/BA-SW-00	IPD/BA-SW-01
	15	IPD/BA-SW-02	-

Captive screw included. 1.20 Hex Screwdriver.



PSD OVERDENTURE ABUTMENT

Platform	Height (mm)	Reference
ø4.1	1.0	IPD/AA-LR-01
	2.0	IPD/AA-LR-02
	3.0	IPD/AA-LR-03
	4.0	IPD/AA-LR-04
	5.0	IPD/AA-LR-05



Please see page 208 for the PSD system accessories. >

Ti-BASE Custom Interface System™

Platform	Height (mm)		
ø4.1	0.5	IPD/AA-IR-00/3D	IPD/AA-IR-01/3D
	1.5	IPD/AA-IR-02/3D	IPD/AA-IR-03/3D
	2.5	IPD/AA-IR-04/3D	IPD/AA-IR-05/3D
ø5.1	0.5	IPD/BA-IW-00/3D	IPD/BA-IW-01/3D
	1.5	IPD/BA-IW-02/3D	IPD/BA-IW-03/3D

High version of the non-engaging Custom Ti-Base subject to availability. Please see page 188 for the Custom Interface System™ accessories. >





COMPATIBILITY
HB Series MICRODENT® UNIVERSAL™
 [ø3.5 / ø4.1 / ø5.1]



TEMPORARY ABUTMENT / OPEN TRAY COPING

Platform			Coping screw
ø4.1	IPD/AA-PR-06	IPD/AA-PR-07	IPD/AA-TR-00/C

The same abutment can be used as a temporary abutment with the occlusal screw or as an impression coping using the coping screw.



OPEN AND CLOSED TRAY COPING

Platform		Reference
ø4.1	Open tray coping	IPD/AA-CR-00
	Closed tray coping	IPD/AA-CR-01
ø5.1	Open tray coping	IPD/BA-CW-00

Classic design.



HEALING ABUTMENT

Platform	Height (mm)	Reference
ø4.1	2.0	IPD/AA-DR-02
	3.0	IPD/AA-DR-03
	4.0	IPD/AA-DR-04
	5.0	IPD/AA-DR-05
	2.0	IPD/BA-DW-02
ø5.1	3.0	IPD/BA-DW-03
	4.0	IPD/BA-DW-04



STRAIGHT AND ANGLED ABUTMENT

Straight, 15° & 25°

Platform	Height (mm)	Angulation		
ø4.1	1.0	Straight	IPD/AA-PR-00	IPD/AA-PR-01
		15°	IPD/AA-PR-02	-
	25°	IPD/AA-PR-03	-	
	2.0	15°	IPD/AA-PR-04	-
		25°	IPD/AA-PR-05	-

Using the low profile IPD/AA-TR-01 screw for IPD/AA-PR-03 is recommended.



CASTABLE

Platform		
ø3.5	IPD/HA-HN-00	IPD/HA-RN-00
ø4.1	IPD/AA-HR-00	IPD/AA-RR-00
ø5.1	IPD/BA-HW-00	IPD/BA-RW-00



Compatibility
DENTSPLY®

IA Series
XIVE® FRIADENT®
 [ø3.4 / ø3.8 / ø4.5]

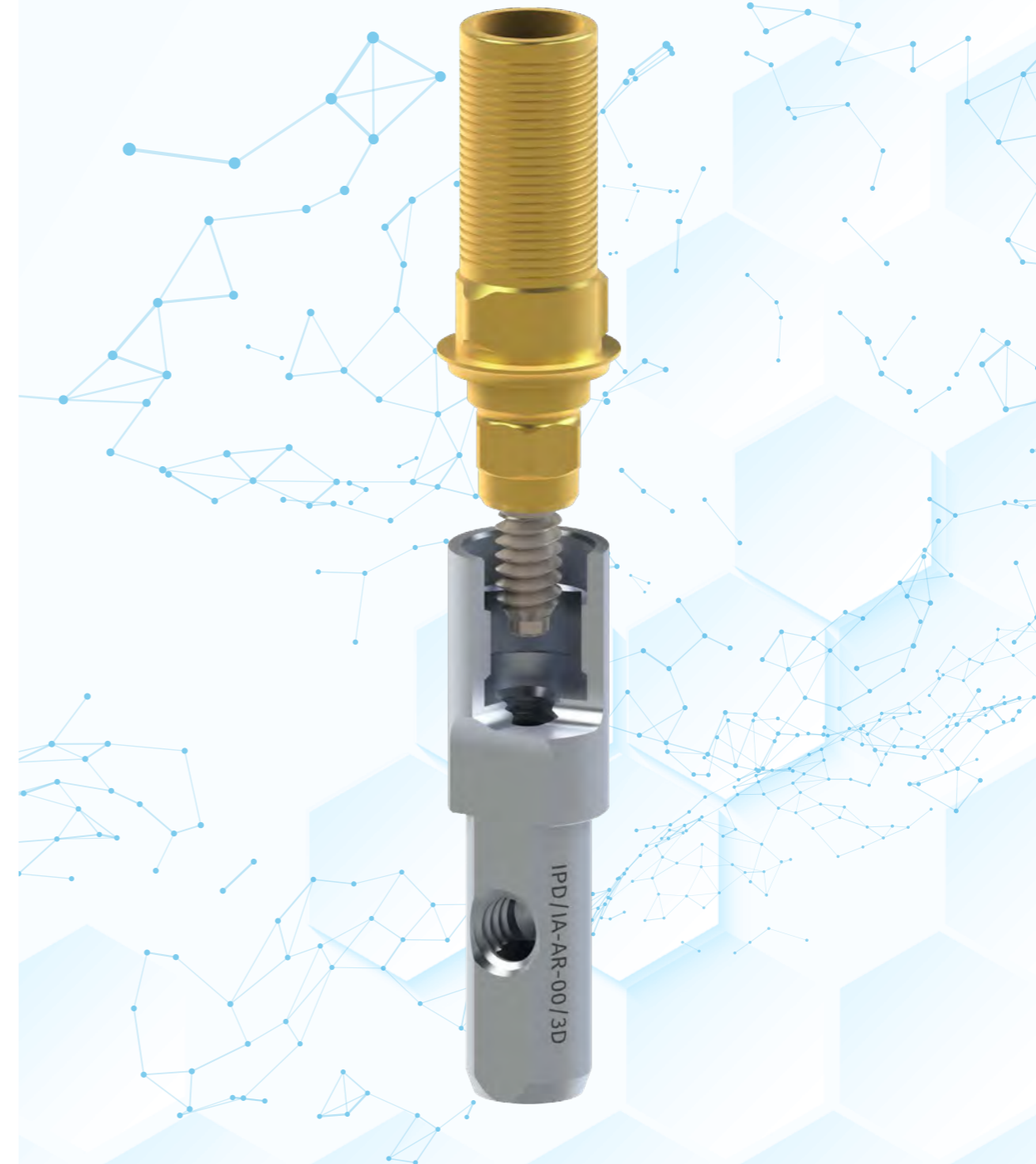



ANALOG / DIGITAL ANALOG

Platform	Reference	Digital reference
ϕ 3.4	IPD/IA-AN-00	IPD/IA-AN-00/3D
ϕ 3.8	IPD/IA-AR-00	IPD/IA-AR-00/3D
ϕ 4.5	IPD/IA-AW-00	-
Lower Screw	-	IPD/KA-TA-00
Transverse Screw	-	IPD/KA-TA-01



STRAIGHT AND ANGLED CASTABLE ABUTMENT WITH A Co-Cr BASE Straight, 15° & 25°

Platform	Angulation		
ϕ 3.4	Straight	IPD/IA-BN-00	IPD/IA-BN-01
	Straight	IPD/IA-BR-00	IPD/IA-BR-01
ϕ 3.8	15°	IPD/IA-BR-10	IPD/IA-BR-11
	25°	IPD/IA-BR-20	IPD/IA-BR-21



All angled castable abutments include a TPA screw.

SCREW

Platform	Screwdriver	Seat	Reference	TiN Reference
ϕ 3.4 / ϕ 3.8 / ϕ 4.5	1.20 Hex	Conical	IPD/IA-TR-00	IPD/IA-TR-00/TIN

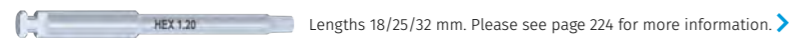

Co-Cr 3D BASE / SCAN BODY

Platform			Scan Body
ϕ 3.4	Straight / Angled	IPD/IA-BN-00/3D	IPD/IA-BN-01/3D
ϕ 3.8	Straight / Angled	IPD/IA-BR-00/3D	IPD/IA-BR-01/3D



TPA SCREW FOR ANGLED PROSTHESIS

Platform	Screwdriver	Seat	Reference
ϕ 3.4 / ϕ 3.8 / ϕ 4.5	TPA	Conical	IPD/IA-TR-50



TEMPORARY ABUTMENT/ OPEN TRAY COPING

Platform			Coping screw
ϕ 3.4	IPD/IA-PN-06	IPD/IA-PN-07	IPD/IA-TR-00/C
ϕ 3.8	IPD/IA-PR-06	IPD/IA-PR-07	IPD/IA-TR-00/C
ϕ 4.5	IPD/IA-PW-06	IPD/IA-PW-07	IPD/IA-TR-00/C

The same abutment can be used as a temporary abutment with the occlusal screw or as an impression coping using the coping screw.



INTRA-ORAL / DESKTOP / CONTACT PROBE SCAN BODY

Platform	Height (mm)		
ϕ 3.4	10	IPD/IA-SN-00	IPD/IA-SN-01
	15	IPD/IA-SN-02	-
ϕ 3.8	10	IPD/IA-SR-00	IPD/IA-SR-01
	15	IPD/IA-SR-02	-

Captive screw included. 1.20 Hex Screwdriver.



HEALING ABUTMENT

Platform	Height (mm)	Straight
ϕ 3.4	2.0	IPD/IA-DN-02
	3.5	IPD/IA-DN-03
	5.0	IPD/IA-DN-05
ϕ 3.8	2.0	IPD/IA-DR-02
	3.5	IPD/IA-DR-03
	5.0	IPD/IA-DR-05
ϕ 4.5	2.0	IPD/IA-DW-02
	3.5	IPD/IA-DW-03
	5.0	IPD/IA-DW-05



Ti-BASE

Platform	Height (mm)		
ϕ 3.4	1.5	IPD/IA-IN-02/3D	IPD/IA-IN-03/3D
	0.5	IPD/IA-IR-00/3D	IPD/IA-IR-01/3D
ϕ 3.8	1.5	IPD/IA-IR-02/3D	IPD/IA-IR-03/3D

High version of the non-engaging Custom Ti-Base subject to availability. Please see page 188 for the accessories. >



CASTABLE

Platform		
ϕ 3.8	IPD/IA-HR-00	IPD/IA-RR-00
ϕ 4.5	IPD/IA-HW-00	IPD/IA-RW-00



Compatibility
DENTSPLY®

IB Series
ANKYLOS®
[C/X]





COMPATIBILITY
IB Series
[c/x]

ANKYLOS®



COMPATIBILITY
IB Series
[c/x]

ANKYLOS®
[c/x]



ANALOG / DIGITAL ANALOG

Platform	Reference	Digital reference
C/X	IPD/IB-AR-00	IPD/IB-AR-00/3D
Lower Screw	-	IPD/KA-TA-00
Transverse Screw	-	IPD/KA-TA-01



SCREW

Platform	Screwdriver	Seat	Reference
C/X	1.00 Hex	Conical for Balance base Narrow	IPD/IB-TR-00
		Conical for non-engaging Ti-Base	IPD/IB-TR-01

 Lengths 18/25/32 mm. Please see page 224 for more information. >



TPA SCREW FOR ANGLED PROSTHESIS



Platform	Screwdriver	Seat	Reference
C/X	TPA	Conical	IPD/IB-TR-51

IPD/IB-TR-51 is a specific screw for the IPD/IB-IR-31 Ti-Bases.

 Lengths 18/25/32 mm. Please see page 226 for more information. >





INTRA-ORAL / DESKTOP / CONTACT PROBE SCAN BODY

Platform	Height (mm)		
C/X	10	IPD/IB-SR-00	IPD/IB-SR-01
	15	IPD/IB-SR-02	-

Captive screw included. 1.20 Hex Screwdriver.



Ti-BASE

Platform	Height (mm)		
C/X	1.5	IPD/IB-IR-02/3D	IPD/IB-IR-03/3D
	2.5	IPD/IB-IR-04/3D	IPD/IB-IR-05/3D

The screw comes included with the Ankylos® system Ti-Bases.
High version of the engaging Custom Ti-Base subject to availability.
Please see page 188 for the  accessories. >



OPEN TRAY COPING

Platform	Reference
C/X	Open tray coping

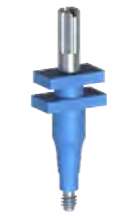

HEALING ABUTMENT

Platform	Height (mm)	Reference
C/X	3.0	IPD/IB-DR-03



Compatibility
CAMLOG®
JA Series
CAMLOG®
[Ø3.3 / Ø3.8 / Ø4.3]

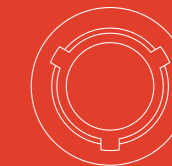



ANALOG / DIGITAL ANALOG

Platform	Reference	Digital reference
ø3.3	IPD/JA-AN-00	IPD/JA-AN-00/3D
ø3.8	IPD/JA-AR-00	IPD/JA-AR-00/3D
ø4.3	IPD/JA-AW-00	IPD/JA-AW-00/3D
Lower Screw	-	IPD/KA-TA-00
Transverse Screw	-	IPD/KA-TA-01





SCREW

Platform	Screwdriver	Seat	Reference	TiN Reference
ø3.3 ø3.8 ø4.3	1.25 Hex	Conical	IPD/JA-TR-00	IPD/JA-TR-00/TIN

 HEX 1.25 Lengths 18/25/32 mm. Please see page 224 for more information. >





INTRA-ORAL / DESKTOP / CONTACT PROBE SCAN BODY

Platform	Height (mm)		
ø3.3	10	IPD/JA-SN-00	IPD/JA-SN-01
	15	IPD/JA-SN-02	-
ø3.8	10	IPD/JA-SR-00	IPD/JA-SR-01
	15	IPD/JA-SR-02	-
ø4.3	10	IPD/JA-SW-00	IPD/JA-SW-01
	15	IPD/JA-SW-02	-

Captive screw included. 1.20 Hex Screwdriver.



Ti-BASE

Platform	Height (mm)		
ø3.3	1.5	IPD/JA-IN-02/3D	IPD/JA-IN-03/3D
	0.5	IPD/JA-IR-00/3D	IPD/JA-IR-01/3D
ø3.8	1.5	IPD/JA-IR-02/3D	IPD/JA-IR-03/3D
	0.5	IPD/JA-IW-00/3D	IPD/JA-IW-01/3D
ø4.3	1.5	IPD/JA-IW-02/3D	IPD/JA-IW-03/3D

High version of the non-engaging Custom Ti-Base subject to availability.
Please see page 188 for the  accessories. >





PSD OVERDENTURE ABUTMENT

Platform	Height (mm)	Reference
ø3.8	1.0	IPD/JA-LR-01
	3.0	IPD/JA-LR-03
	5.0	IPD/JA-LR-05

Please see page 208 for the PSD system accessories. >



TEMPORARY ABUTMENT/ OPEN TRAY COPING

Platform			Coping screw
ø3.3	IPD/JA-PN-06	IPD/JA-PN-07	IPD/JA-TR-00/C
ø3.8	IPD/JA-PR-06	IPD/JA-PR-07	
ø4.3	IPD/JA-PW-06	IPD/JA-PW-07	

The same abutment can be used as a temporary abutment with the occlusal screw or as an impression coping using the coping screw.



HEALING ABUTMENT

Platform	Height (mm)	Straight
ø3.3	2.0	IPD/JA-DN-02
	4.0	IPD/JA-DN-04
	6.0	IPD/JA-DN-06
ø3.8	2.0	IPD/JA-DR-02
	4.0	IPD/JA-DR-04
	6.0	IPD/JA-DR-06
ø4.3	2.0	IPD/JA-DW-02
	4.0	IPD/JA-DW-04
	6.0	IPD/JA-DW-06



Compatibility
BIOHORIZONS®

LB Series
TAPERED INTERNAL
[ϕ 3.0 / ϕ 3.5 / ϕ 4.5 / ϕ 5.7]

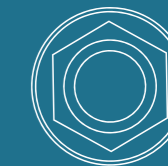



COMPATIBILITY LB Series TAPERED INTERNAL [ϕ 3.0 / ϕ 3.5 / ϕ 4.5 / ϕ 5.7]



COMPATIBILITY LB Series TAPERED INTERNAL [ϕ 3.0 / ϕ 3.5 / ϕ 4.5 / ϕ 5.7]



ANALOG / DIGITAL ANALOG

Platform	Reference	Digital reference
ϕ 3.0	IPD/LB-AT-00	IPD/LB-AT-00/3D
ϕ 3.5	IPD/LB-AN-00	IPD/LB-AN-00/3D
ϕ 4.5	IPD/LB-AR-00	IPD/LB-AR-00/3D
ϕ 5.7	IPD/LB-AW-00	IPD/LB-AW-00/3D
Lower Screw	-	IPD/KA-TA-00
Transverse Screw	-	IPD/KA-TA-01



SCREW

Platform	Screwdriver	Seat	Reference	TiN Reference
ϕ 3.0 ϕ 3.5 ϕ 4.5 ϕ 5.7	Hexagonal 1.27	Conical	IPD/LB-TR-00	IPD/LB-TR-00/TiN

 HEX 1.27 Lengths 18/25/32 mm. Please see page 224 for more information. >





TPA SCREW FOR ANGLED PROSTHESIS

Platform	Screwdriver	Seat	Reference
ϕ 3.0 ϕ 3.5 ϕ 4.5 ϕ 5.7	TPA	Conical	IPD/LB-TR-50

 Lengths 18/25/32 mm. Please see page 226 for more information. >





INTRA-ORAL / DESKTOP / CONTACT PROBE SCAN BODY

Platform	Height (mm)		
ϕ 3.0	10	IPD/LB-ST-00	IPD/LB-ST-01
	15	IPD/LB-ST-02	-
ϕ 3.5	10	IPD/LB-SN-00	IPD/LB-SN-01
	15	IPD/LB-SN-02	-
ϕ 4.5	10	IPD/LB-SR-00	IPD/LB-SR-01
	15	IPD/LB-SR-02	-
ϕ 5.7	10	IPD/LB-SW-00	IPD/LB-SW-01
	15	IPD/LB-SW-02	-

Captive screw included. 1.20 Hex Screwdriver.



Ti-BASE

Platform	Height (mm)		
ϕ 3.0	0.5	IPD/LB-IT-00/3D	IPD/LB-IT-01/3D
	1.5	IPD/LB-IT-02/3D	IPD/LB-IT-03/3D
	2.5	IPD/LB-IT-04/3D	IPD/LB-IT-05/3D
ϕ 3.5	0.5	IPD/LB-IN-00/3D	IPD/LB-IN-01/3D
	1.5	IPD/LB-IN-02/3D	IPD/LB-IN-03/3D
	2.5	IPD/LB-IN-04/3D	IPD/LB-IN-05/3D
ϕ 4.5	0.5	IPD/LB-IR-00/3D	IPD/LB-IR-01/3D
	1.5	IPD/LB-IR-02/3D	IPD/LB-IR-03/3D
	2.5	IPD/LB-IR-04/3D	IPD/LB-IR-05/3D
ϕ 5.7	0.5	IPD/LB-IW-00/3D	IPD/LB-IW-01/3D

High version of the non-engaging Custom Ti-Base subject to availability. Please see page 188 for the  accessories. >



STRAIGHT AND ANGLED MULTI-UNIT ABUTMENT

Straight, 17° & 30°



Platform	Height (mm)	Straight	17°	30°
ϕ 3.5	1.5	IPD/FA-MN-01	-	-
	2.5	IPD/FA-MN-02	IPD/LB-MN-12	-
	3.5	IPD/FA-MN-03	IPD/LB-MN-13	IPD/LB-MN-33
	4.5	IPD/FA-MN-04	-	IPD/LB-MN-34
ϕ 4.5	1.5	IPD/FA-MR-01	-	-
	2.5	IPD/FA-MR-02	-	-
	3.5	IPD/FA-MR-03	-	-
	4.5	IPD/FA-MR-04	-	-



Our straight multi-units can be used for single and multiple restorations. Please see page 198 for the Multi-unit system accessories. >

STRAIGHT AND ANGLED CASTABLE ABUTMENT WITH A Co-Cr BASE

Straight, 15° & 25°

Platform	Angulation		
ϕ 3.0	Straight	IPD/LB-BT-00	IPD/LB-BT-01
	15°	IPD/LB-BT-10	IPD/LB-BT-11
	25°	IPD/LB-BT-20	IPD/LB-BT-21
ϕ 3.5	Straight	IPD/LB-BN-00	IPD/LB-BN-01
	15°	IPD/LB-BN-10	IPD/LB-BN-11
	25°	IPD/LB-BN-20	IPD/LB-BN-21
ϕ 4.5	Straight	IPD/LB-BR-00	IPD/LB-BR-01
	15°	IPD/LB-BR-10	IPD/LB-BR-11
	25°	IPD/LB-BR-20	IPD/LB-BR-21



All angled castable abutments include a TPA screw.





COMPATIBILITY
LB Series TAPERED INTERNAL
[ϕ 3.0 / ϕ 3.5 / ϕ 4.5 / ϕ 5.7]



COMPATIBILITY
LB Series TAPERED INTERNAL
[ϕ 3.0 / ϕ 3.5 / ϕ 4.5 / ϕ 5.7]



Co-Cr 3D BASE / SCAN BODY

Platform				Scan Body
ϕ 3.0	Straight / Angled	IPD/LB-BT-00/3D	IPD/LB-BT-01/3D	IPD/SC-AN-B1
ϕ 3.5	Straight / Angled	IPD/LB-BN-00/3D	IPD/LB-BN-01/3D	IPD/SC-AN-B1
ϕ 4.5	Straight / Angled	IPD/LB-BR-00/3D	IPD/LB-BR-01/3D	IPD/SC-AN-B1



PSD OVERDENTURE ABUTMENT

Platform	Height (mm)	Reference
ϕ 3.0	2.0	IPD/LB-LT-02
	3.0	IPD/LB-LT-03
	4.0	IPD/LB-LT-04
	5.0	IPD/LB-LT-05
ϕ 3.5	1.0	IPD/FA-LN-01
	2.0	IPD/FA-LN-02
	3.0	IPD/FA-LN-03
	4.0	IPD/FA-LN-04
	5.0	IPD/FA-LN-05
ϕ 4.5	1.0	IPD/FA-LR-01
	2.0	IPD/FA-LR-02
	3.0	IPD/FA-LR-03
	4.0	IPD/FA-LR-04
	5.0	IPD/FA-LR-05





HEALING ABUTMENT

Platform	Height (mm)	Reference
ϕ 3.0	2.0	IPD/LB-DT-02
	3.0	IPD/LB-DT-03
	5.0	IPD/LB-DT-05
ϕ 3.5	1.5	IPD/FA-DN-01
	3.0	IPD/FA-DN-03
	5.0	IPD/FA-DN-05
ϕ 4.5	1.5	IPD/FA-DR-01
	3.0	IPD/FA-DR-03
	5.0	IPD/FA-DR-05





CASTABLE

Platform		
ϕ 3.5	IPD/LB-HN-00	IPD/LB-RN-00
ϕ 4.5	IPD/LB-HR-00	IPD/LB-RR-00
ϕ 5.7	IPD/LB-HW-00	IPD/LB-RW-00



Please see page 208 for the PSD system accessories.

TEMPORARY ABUTMENT/ OPEN TRAY COPING

Platform			Coping screw
ϕ 3.0	IPD/LB-PT-06	IPD/LB-PT-07	IPD/LB-TR-00/C
ϕ 3.5	IPD/LB-PN-06	IPD/LB-PN-07	
ϕ 4.5	IPD/LB-PR-06	IPD/LB-PR-07	
ϕ 5.7	IPD/LB-PW-06	IPD/LB-PW-07	

The same abutment can be used as a temporary abutment with the occlusal screw or as an impression coping using the coping screw.



OPEN TRAY COPING

Platform	Reference
ϕ 5.7	Open tray coping IPD/LB-CW-00

Classic design.



Compatibility
SWEDEN & MARTINA®

MA Series
OUTLINK®
[ϕ 3.3 / ϕ 4.1 / ϕ 5.0]





ANALOG / DIGITAL ANALOG

Platform	Reference	Digital reference
ø3.3	IPD/MA-AN-00	IPD/MA-AN-00/3D
ø4.1	IPD/AA-AR-00	IPD/AA-AR-00/3D
ø5.0	IPD/BA-AW-00	IPD/BA-AW-00/3D
Lower Screw	-	IPD/KA-TA-00
Transverse Screw	-	IPD/KA-TA-01

SCREW

Platform	Screwdriver	Seat	Reference	TiN Reference
ø3.3	1.25 Hex	Conical	IPD/MA-TN-00	IPD/MA-TN-00/TIN
ø4.1 ø5.0	1.25 Hex	Conical	IPD/BA-TR-01	IPD/BA-TR-01/TIN
	1.20 Hex	Low profile conical	IPD/AA-TR-01	IPD/AA-TR-01/TIN

HEX 1.20 Lengths 18/25/32 mm. Please see page 224 for more information. >

HEX 1.25 Lengths 18/25/32 mm. Please see page 224 for more information. >

TPA SCREW FOR ANGLED PROSTHESIS

Platform	Screwdriver	Seat	Reference
ø3.3	TPA	Conical	IPD/MA-TN-50
ø4.1 ø5.0	TPA	Conical	IPD/AA-TR-50
	TPA	Flat	IPD/AA-TR-52

Lengths 18/25/32 mm. Please see page 226 for more information. >

INTRA-ORAL / DESKTOP / CONTACT PROBE SCAN BODY

Platform	Height (mm)		
ø3.3	10	IPD/MA-SN-00	IPD/MA-SN-01
	15	IPD/MA-SN-02	-
ø4.1	10	IPD/AA-SR-00	IPD/AA-SR-01
	15	IPD/AA-SR-02	-
ø5.0	10	IPD/BA-SW-00	IPD/BA-SW-01
	15	IPD/BA-SW-02	-

Captive screw included. 1.20 Hex Screwdriver.

Ti-BASE Custom Interface System™

Platform	Height (mm)		
ø3.3	1.5	IPD/MA-IN-02/3D	IPD/MA-IN-03/3D
	2.5	IPD/MA-IN-04/3D	IPD/MA-IN-05/3D
	0.5	IPD/AA-IR-00/3D	IPD/AA-IR-01/3D
ø4.1	1.5	IPD/AA-IR-02/3D	IPD/AA-IR-03/3D
	2.5	IPD/AA-IR-04/3D	IPD/AA-IR-05/3D
	0.5	IPD/BA-IW-00/3D	IPD/BA-IW-01/3D
ø5.0	1.5	IPD/BA-IW-02/3D	IPD/BA-IW-03/3D

High version of the non-engaging Custom Ti-Base subject to availability. Please see page 188 for the accessories. >

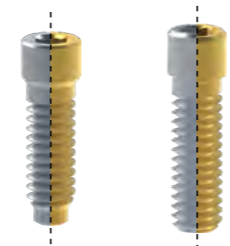

STRAIGHT AND ANGLED MULTI-UNIT ABUTMENT

Straight, 17° & 30°

Platform	Height (mm)	Straight	17°	30°
ø4.1	1.0	IPD/AB-MR-01	-	-
	2.0	IPD/AB-MR-02	IPD/AB-MR-12	-
	3.0	IPD/AB-MR-03	IPD/AB-MR-13	IPD/AB-MR-33
	4.0	IPD/AB-MR-04	IPD/AB-MR-14	IPD/AB-MR-34
	5.0	IPD/AB-MR-05	-	IPD/AB-MR-35

Our straight multi-units can be used for single and multiple restorations. Please see page 198 for the Multi-unit system accessories. >



STRAIGHT AND ANGLED CASTABLE ABUTMENT WITH A Co-Cr BASE

Straight, 15° & 25°

Platform	Angulation		
ø3.3	Straight	IPD/MA-BN-00	IPD/MA-BN-01
	15°	IPD/MA-BN-10	IPD/MA-BN-11
ø4.1	Straight	IPD/AA-BR-00	IPD/AA-BR-01
	15°	IPD/AA-BR-10	IPD/AA-BR-11
	25°	IPD/AA-BR-20	IPD/AA-BR-21
ø5.0	Straight	IPD/BA-BW-00	IPD/BA-BW-01
	15°	IPD/BA-BW-10	IPD/BA-BW-11
	25°	IPD/BA-BW-20	IPD/BA-BW-21

All angled castable abutments include a TPA screw.



Co-Cr 3D BASE / SCAN BODY

Platform			Scan Body	
ø3.3	Straight / Angled	IPD/MA-BN-00/3D	IPD/MA-BN-01/3D	IPD/SC-AN-B1
ø4.1	Straight / Angled	IPD/AA-BR-00/3D	IPD/AA-BR-01/3D	IPD/SC-AN-B1
ø5.0	Straight / Angled	IPD/BA-BW-00/3D	IPD/BA-BW-01/3D	IPD/SC-AN-B1



PSD OVERDENTURE ABUTMENT

Platform	Height (mm)	Reference
ø3.3	2.0	IPD/MA-LN-02
	3.0	IPD/MA-LN-03
	4.0	IPD/MA-LN-04
	5.0	IPD/MA-LN-05
	1.0	IPD/AA-LR-01
ø4.1	2.0	IPD/AA-LR-02
	3.0	IPD/AA-LR-03
	4.0	IPD/AA-LR-04
	5.0	IPD/AA-LR-05

Please see page 208 for the PSD system accessories. >





COMPATIBILITY
MA Series OUTLINK®
[ϕ 3.3 / ϕ 4.1 / ϕ 5.0]



TEMPORARY ABUTMENT/ OPEN TRAY COPING

Platform			Coping screw
ϕ 3.3	IPD/MA-PN-06	IPD/MA-PN-07	IPD/MA-TN-00/C
ϕ 4.1	IPD/AA-PR-06	IPD/AA-PR-07	IPD/AA-TR-00/C

The same abutment can be used as a temporary abutment with the occlusal screw or as an impression coping using the coping screw.

OPEN AND CLOSED TRAY COPING

Platform		Reference
ϕ 4.1	Open tray coping	IPD/AA-CR-00
	Closed tray coping	IPD/AA-CR-01
ϕ 5.0	Open tray coping	IPD/BA-CW-00

Classic design.

HEALING ABUTMENT

Platform	Height (mm)	Reference
ϕ 3.3	3.0	IPD/MA-DN-03
	4.0	IPD/MA-DN-04
	5.0	IPD/MA-DN-05
ϕ 4.1	2.0	IPD/AA-DR-02
	3.0	IPD/AA-DR-03
	4.0	IPD/AA-DR-04
ϕ 5.0	5.0	IPD/AA-DR-05
	2.0	IPD/BA-DW-02
	3.0	IPD/BA-DW-03
	4.0	IPD/BA-DW-04

STRAIGHT AND ANGLED ABUTMENT

Straight, 15° & 25°

Platform	Height (mm)	Angulation		
ϕ 4.1	1.0	Straight	IPD/AA-PR-00	IPD/AA-PR-01
		15°	IPD/AA-PR-02	-
		25°	IPD/AA-PR-03	-
	2.0	15°	IPD/AA-PR-04	-
		25°	IPD/AA-PR-05	-

Using the low profile IPD/AA-TR-01 screw for IPD/AA-PR-03 is recommended.

CASTABLE

Platform		
ϕ 4.1	IPD/AA-HR-00	IPD/AA-RR-00
ϕ 5.0	IPD/BA-HW-00	IPD/BA-RW-00



Compatibility
SWEDEN & MARTINA®

MB Series PREMIUM™ KOHNO®
[ϕ 3.3 / ϕ 3.8 / ϕ 4.25 / ϕ 5.0]





COMPATIBILITY
MB Series PREMIUM™ KOHNO®
[ø3.3 / ø3.8 / ø4.25 / ø5.0]



COMPATIBILITY
MB Series PREMIUM™ KOHNO®
[ø3.3 / ø3.8 / ø4.25 / ø5.0]

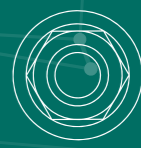

ANALOG / DIGITAL ANALOG

Platform	Reference	Digital reference
ø3.3	IPD/MB-AT-00	IPD/MB-AT-00/3D
ø3.8	IPD/MB-AN-00	IPD/MB-AN-00/3D
ø4.25	IPD/MB-AR-00	IPD/MB-AR-00/3D
ø5.0	IPD/MB-AW-00	-
Lower Screw	-	IPD/KA-TA-00
Transverse Screw	-	IPD/KA-TA-01



Ti-BASE Custom Interface System™

Platform	Height (mm)		
ø3.3	0.5	IPD/MB-IT-00/3D	IPD/MB-IT-01/3D
	1.5	IPD/MB-IT-02/3D	IPD/MB-IT-03/3D
ø3.8	0.7	IPD/MB-IN-00/3D	IPD/MB-IN-01/3D
	1.5	IPD/MB-IN-02/3D	IPD/MB-IN-03/3D
ø4.25	0.7	IPD/MB-IR-00/3D	IPD/MB-IR-01/3D
	1.5	IPD/MB-IR-02/3D	IPD/MB-IR-03/3D



High version of the non-engaging Custom Ti-Base subject to availability. Please see page 188 for the Custom Interface System® accessories. >

SCREW

Platform	Screwdriver	Seat	Reference	TiN Reference
ø3.3 ø3.8	1.25 Hex	Conical	IPD/MB-TN-00	IPD/MB-TN-00/TiN
ø4.25 ø5.0	1.25 Hex	Conical	IPD/MB-TR-00	IPD/MB-TR-00/TiN

HEX 1.25 Lengths 18/25/32 mm. Please see page 224 for more information. >



STRAIGHT AND ANGLED CASTABLE ABUTMENT WITH A Co-Cr BASE
Straight, 15° & 25°

Platform	Angulation		
ø3.3	Straight	IPD/MB-BT-00	IPD/MB-BT-01
	15°	IPD/MB-BT-10	IPD/MB-BT-11
ø3.8	Straight	IPD/MB-BN-00	IPD/MB-BN-01
	15°	IPD/MB-BN-10	IPD/MB-BN-11
	25°	IPD/MB-BN-20	IPD/MB-BN-21
ø4.25	Straight	IPD/MB-BR-00	IPD/MB-BR-01
	15°	IPD/MB-BR-10	IPD/MB-BR-11
	25°	IPD/MB-BR-20	IPD/MB-BR-21



All angled castable abutments include a TPA screw.

TPA SCREW FOR ANGLED PROSTHESIS

Platform	Screwdriver	Seat	Reference
ø3.3 ø3.8	TPA	Conical	IPD/MB-TN-50
ø4.25 ø5.0	TPA	Conical	IPD/MB-TR-50

Lengths 18/25/32 mm. Please see page 226 for more information. >



Co-Cr 3D BASE / SCAN BODY

Platform			Scan Body	
ø3.3	Straight / Angled	IPD/MB-BT-00/3D	IPD/MB-BT-01/3D	IPD/SC-AN-B1
ø3.8	Straight / Angled	IPD/MB-BN-00/3D	IPD/MB-BN-01/3D	IPD/SC-AN-B1
ø4.25	Straight / Angled	IPD/MB-BR-00/3D	IPD/MB-BR-01/3D	IPD/SC-AN-B1



INTRA-ORAL / DESKTOP / CONTACT PROBE SCAN BODY

Platform	Height (mm)		
ø3.3	10	IPD/MB-ST-00	IPD/MB-ST-01
	15	IPD/MB-ST-02	-
ø3.8	10	IPD/MB-SN-00	IPD/MB-SN-01
	15	IPD/MB-SN-02	-
ø4.25	10	IPD/MB-SR-00	IPD/MB-SR-01
	15	IPD/MB-SR-02	-

Captive screw included. 1.20 Hex Screwdriver.



PSD OVERDENTURE ABUTMENT

Platform	Height (mm)	Reference
ø3.8	1.0	IPD/MB-LN-01
	3.0	IPD/MB-LN-03
	5.0	IPD/MB-LN-05
ø4.25	1.0	IPD/MB-LR-01
	3.0	IPD/MB-LR-03
	5.0	IPD/MB-LR-05





Please see page 208 for the PSD system accessories. >



COMPATIBILITY
MB Series PREMIUM™ KOHNO®
 [ø3.3 / ø3.8 / ø4.25 / ø5.0]



TEMPORARY ABUTMENT/ OPEN TRAY COPING

Platform			Coping screw
ø3.3	IPD/MB-PT-06	IPD/MB-PT-07	IPD/MB-TN-00/C
ø3.8	IPD/MB-PN-06	IPD/MB-PN-07	IPD/MB-TN-00/C
ø4.25	IPD/MB-PR-06	IPD/MB-PR-07	IPD/MB-TR-00/C



The same abutment can be used as a temporary abutment with the occlusal screw or as an impression coping using the coping screw.



HEALING ABUTMENT

Platform	Height (mm)	Reference
ø3.8	2.0	IPD/MB-DN-02
	3.0	IPD/MB-DN-03
	4.0	IPD/MB-DN-04
	6.0	IPD/MB-DN-06
ø4.25	2.0	IPD/MB-DR-02
	3.0	IPD/MB-DR-03
	4.0	IPD/MB-DR-04
	6.0	IPD/MB-DR-06

CASTABLE

Platform		
ø3.8	IPD/MB-HN-00	IPD/MB-RN-00
ø4.25	IPD/MB-HR-00	IPD/MB-RR-00
ø5.0	IPD/MB-HW-00	IPD/MB-RW-00

Compatibility
PHIBO®
 NA Series
TSH®
 [S2 / S3-S4 / S5]





ANALOG / DIGITAL ANALOG

Platform	Reference	Digital reference
S2	IPD/NA-AN-00	IPD/NA-AN-00/3D
S3-S4	IPD/AA-AR-00	IPD/AA-AR-00/3D
S5	IPD/HA-AW-00	IPD/NA-AW-00/3D
Lower Screw	-	IPD/KA-TA-00
Transverse Screw	-	IPD/KA-TA-01



SCREW

Platform	Screwdriver	Seat	Reference	TiN Reference
S2	1.25 Hex	Conical	IPD/NA-TN-00	IPD/NA-TN-00/TIN
S3-S4	1.25 Hex	Conical	IPD/BA-TR-01	IPD/BA-TR-01/TIN
	1.20 Hex	Low profile conical	IPD/AA-TR-01	IPD/AA-TR-01/TIN
S5	1.25 Hex	Conical	IPD/NA-TW-00	-

HEX 1.20 Lengths 18/25/32 mm. Please see page 224 for more information. >

HEX 1.25 Lengths 18/25/32 mm. Please see page 224 for more information. >

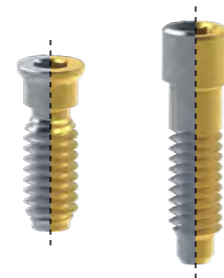

TPA SCREW FOR ANGLED PROSTHESIS

Platform	Screwdriver	Seat	Reference
S2	TPA	Conical	IPD/MB-TN-50
S3-S4	TPA	Conical	IPD/AA-TR-50
	TPA	Flat	IPD/AA-TR-52
S5	TPA	Conical	IPD/MB-TR-50

Lengths 18/25/32 mm. Please see page 226 for more information. >



INTRA-ORAL / DESKTOP / CONTACT PROBE SCAN BODY

Platform	Height (mm)		
S2	10	IPD/NA-SN-00	IPD/NA-SN-01
	15	IPD/NA-SN-02	-
S3-S4	10	IPD/AA-SR-00	IPD/AA-SR-01
	15	IPD/AA-SR-02	-
S5	10	IPD/NA-SW-00	IPD/NA-SW-01

Captive screw included. 1.20 Hex Screwdriver.



Ti-BASE

Platform	Height (mm)		
S2	1.5	IPD/NA-IN-02/3D	IPD/NA-IN-03/3D
	0.5	IPD/AA-IR-00/3D	IPD/AA-IR-01/3D
S3-S4	1.5	IPD/AA-IR-02/3D	IPD/AA-IR-03/3D
	2.5	IPD/AA-IR-04/3D	IPD/AA-IR-05/3D
S5	1.3	IPD/NA-IW-02/3D	IPD/NA-IW-03/3D

High version of the non-engaging Custom Ti-Base subject to availability. Please see page 188 for the accessories. >



STRAIGHT AND ANGLED MULTI-UNIT ABUTMENT

Straight, 17° & 30°

Platform	Height (mm)	Straight	17°	30°
S3-S4	1.0	IPD/AB-MR-01	-	-
	2.0	IPD/AB-MR-02	IPD/AB-MR-12	-
	3.0	IPD/AB-MR-03	IPD/AB-MR-13	IPD/AB-MR-33
	4.0	IPD/AB-MR-04	IPD/AB-MR-14	IPD/AB-MR-34
	5.0	IPD/AB-MR-05	-	IPD/AB-MR-35

Our straight multi-units can be used for single and multiple restorations. Please see page 198 for the Multi-unit system accessories. >



STRAIGHT AND ANGLED CASTABLE ABUTMENT WITH A Co-Cr BASE

Straight, 15° & 25°

Platform	Angulation		
S3-S4	Straight	IPD/AA-BR-00	IPD/AA-BR-01
	15°	IPD/AA-BR-10	IPD/AA-BR-11
	25°	IPD/AA-BR-20	IPD/AA-BR-21

All angled castable abutments include a TPA screw.



Co-Cr 3D BASE / SCAN BODY

Platform			Scan Body
S3-S4	IPD/AA-BR-00/3D	IPD/AA-BR-01/3D	IPD/SC-AN-B1







PSD OVERDENTURE ABUTMENT

Platform	Height (mm)	Reference
S2	1.0	IPD/NA-LN-01
	3.0	IPD/NA-LN-03
	1.0	IPD/AA-LR-01
S3-S4	2.0	IPD/AA-LR-02
	3.0	IPD/AA-LR-03
	4.0	IPD/AA-LR-04
	5.0	IPD/AA-LR-05

Please see page 208 for the PSD system accessories. >



TEMPORARY ABUTMENT/ OPEN TRAY COPING

Platform			Coping screw
S2	IPD/NA-PN-06	IPD/NA-PN-07	IPD/NA-TN-00/C
S3-S4	IPD/AA-PR-06	IPD/AA-PR-07	IPD/AA-TR-00/C
S5	IPD/NA-PW-06	IPD/NA-PW-07	IPD/NA-TW-00/C

The same abutment can be used as a temporary abutment with the occlusal screw or as an impression coping using the coping screw.



OPEN AND CLOSED TRAY COPING

Platform		Reference
S3-S4	Open tray coping	IPD/AA-CR-00
	Closed tray coping	IPD/AA-CR-01

Classic design.





HEALING ABUTMENT

Platform	Height (mm)	Reference
S2	3.0	IPD/NA-DN-03
	4.0	IPD/NA-DN-04
	5.0	IPD/NA-DN-05
S3-S4	2.0	IPD/AA-DR-02
	3.0	IPD/AA-DR-03
	4.0	IPD/AA-DR-04
	5.0	IPD/AA-DR-05



STRAIGHT AND ANGLED ABUTMENT



Straight, 15° & 25°

Platform	Height (mm)	Angulation		
			IPD/AA-PR-00	IPD/AA-PR-01
S3-S4	1.0	Straight	IPD/AA-PR-00	IPD/AA-PR-01
		15°	IPD/AA-PR-02	-
	25°	IPD/AA-PR-03	-	
	2.0	15°	IPD/AA-PR-04	-
		25°	IPD/AA-PR-05	-

Using the low profile IPD/AA-TR-01 screw for IPD/AA-PR-03 is recommended.



CASTABLE

Platform		
S2	IPD/NA-HN-00	IPD/NA-RN-00
S3-S4	IPD/AA-HR-00	IPD/AA-RR-00
S5	IPD/HA-HW-00	IPD/HA-RW-00



Compatibility
OSSTEM IMPLANT®

OB Series
TSIII
[ø3.5 / ø4.0]

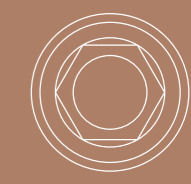



ANALOG / DIGITAL ANALOG

Platform	Reference	Digital reference
ϕ 3.5	IPD/OB-AN-00	IPD/OB-AN-00/3D
ϕ 4.0	IPD/OB-AR-00	IPD/OB-AR-00/3D
Lower Screw	-	IPD/KA-TA-00
Transverse Screw	-	IPD/KA-TA-01



SCREW

Platform	Screwdriver	Seat	Reference	TiN Reference
ϕ 3.5	1.20 Hex	Conical	IPD/OB-TN-00	IPD/OB-TN-00/TIN
ϕ 4.0	1.20 Hex	Conical	IPD/OB-TR-00	IPD/OB-TR-00/TIN

 HEX 1.20 Lengths 18/25/32 mm. Please see page 224 for more information. >





TPA SCREW FOR ANGLED PROSTHESIS

Platform	Screwdriver	Seat	Reference
ϕ 3.5	TPA	Conical	IPD/OB-TN-50
ϕ 4.0	TPA	Conical	IPD/OB-TR-50

 Lengths 18/25/32 mm. Please see page 226 for more information. >





INTRA-ORAL / DESKTOP / CONTACT PROBE SCAN BODY

Platform	Height (mm)		
ϕ 3.5	10	IPD/OB-SN-00	IPD/OB-SN-01
	15	IPD/OB-SN-02	-
ϕ 4.0	10	IPD/OB-SR-00	IPD/OB-SR-01
	15	IPD/OB-SR-02	-

Captive screw included. 1.20 Hex Screwdriver.



Ti-BASE

Platform	Height (mm)		
ϕ 3.5	1.0	IPD/OB-IN-00/3D	IPD/OB-IN-01/3D
	2.0	IPD/OB-IN-02/3D	IPD/OB-IN-03/3D
	3.0	IPD/OB-IN-04/3D	IPD/OB-IN-05/3D
ϕ 4.0	1.0	IPD/OB-IR-00/3D	IPD/OB-IR-01/3D
	2.0	IPD/OB-IR-02/3D	IPD/OB-IR-03/3D
	3.0	IPD/OB-IR-04/3D	IPD/OB-IR-05/3D

Please see page 188 for the  accessories. >





STRAIGHT AND ANGLED MULTI-UNIT ABUTMENT

Platform	Height (mm)	Straight	17°	30°
ϕ 3.5	1.5	IPD/OB-MN-01	-	-
	2.5	IPD/OB-MN-02	IPD/OB-MN-12	-
	3.5	IPD/OB-MN-03	IPD/OB-MN-13	IPD/OB-MN-33
	4.5	IPD/OB-MN-04	-	IPD/OB-MN-34
	5.5	IPD/OB-MN-05	-	-
ϕ 4.0	1.5	IPD/OB-MR-01	-	-
	2.5	IPD/OB-MR-02	IPD/OB-MR-12	-
	3.5	IPD/OB-MR-03	IPD/OB-MR-13	IPD/OB-MR-33
	4.5	IPD/OB-MR-04	-	IPD/OB-MR-34
	5.5	IPD/OB-MR-05	-	-

Our straight multi-units can be used for single and multiple restorations. Please see page 198 for the Multi-unit system accessories. >





STRAIGHT AND ANGLED CASTABLE ABUTMENT WITH A Co-Cr BASE

Platform	Angulation		
ϕ 3.5	Straight	IPD/OB-BN-00	IPD/OB-BN-01
	15°	IPD/OB-BN-10	IPD/OB-BN-11
ϕ 4.0	Straight	IPD/OB-BR-00	IPD/OB-BR-01
	15°	IPD/OB-BR-10	IPD/OB-BR-11

All angled castable abutments include a TPA screw.



Co-Cr 3D BASE / SCAN BODY

Platform				Scan Body
ϕ 3.5	Straight / Angled	IPD/OB-BN-00/3D	IPD/OB-BN-01/3D	IPD/SC-AN-B1
ϕ 4.0	Straight / Angled	IPD/OB-BR-00/3D	IPD/OB-BR-01/3D	IPD/SC-AN-B1





COMPATIBILITY
OB Series TSIII
[ϕ 3.5 / ϕ 4.0]





PSD OVERDENTURE ABUTMENT

Platform	Height (mm)	Reference
ϕ 3.5	1.0	IPD/OB-LN-01
	2.0	IPD/OB-LN-02
	3.0	IPD/OB-LN-03
	4.0	IPD/OB-LN-04
	5.0	IPD/OB-LN-05
ϕ 4.0	1.0	IPD/OB-LR-01
	2.0	IPD/OB-LR-02
	3.0	IPD/OB-LR-03
	4.0	IPD/OB-LR-04
	5.0	IPD/OB-LR-05

Please see page 208 for the PSD system accessories. >

TEMPORARY ABUTMENT/ OPEN TRAY COPING

Platform			Coping screw
ϕ 3.5	IPD/OB-PN-06	IPD/OB-PN-07	IPD/OB-TN-00/C
ϕ 4.0	IPD/OB-PR-06	IPD/OB-PR-07	IPD/OB-TR-00/C

The same abutment can be used as a temporary abutment with the occlusal screw or as an impression coping using the coping screw.

HEALING ABUTMENT

Platform	Height (mm)	Reference
ϕ 3.5	3.0	IPD/OB-DN-03
	5.0	IPD/OB-DN-05
	7.0	IPD/OB-DN-07
ϕ 4.0	3.0	IPD/OB-DR-03
	5.0	IPD/OB-DR-05
	7.0	IPD/OB-DR-07



Compatibility BIOTECH® DENTAL QB Series KONTACT® [RP]





ANALOG / DIGITAL ANALOG

Platform	Reference	Digital reference
RP	IPD/QB-AR-00	IPD/QB-AR-00/3D
Lower Screw	-	IPD/KA-TA-00
Transverse Screw	-	IPD/KA-TA-01



SCREW

Platform	Screwdriver	Seat	Reference	TiN Reference
RP	1.20 Hex	Conical	IPD/QB-TR-00	IPD/QB-TR-00/TiN
			IPD/QB-TR-01	-

The IPD/QB-TR-01 model is an abutment extractor screw.

 Lengths 18/25/32 mm. Please see page 224 for more information. >



TPA SCREW FOR ANGLED PROSTHESIS



Platform	Screwdriver	Seat	Reference
RP	TPA	Conical	IPD/QB-TR-50

The IPD/QB-TR-01 abutment extractor screw cannot be used if angled systems are used with the Kontakt® system.

 Lengths 18/25/32 mm. Please see page 226 for more information. >





INTRA-ORAL / DESKTOP / CONTACT PROBE SCAN BODY

Platform	Height (mm)		
RP	10	IPD/QB-SR-00	IPD/QB-SR-01
	15	IPD/QB-SR-02	-

Captive screw included. 1.20 Hex Screwdriver.



Ti-BASE

Platform	Height (mm)		
RP	1.0	IPD/QB-IR-00/3D	IPD/QB-IR-01/3D
	2.0	IPD/QB-IR-02/3D	IPD/QB-IR-03/3D
	3.0	IPD/QB-IR-04/3D	IPD/QB-IR-05/3D

Please see page 188 for the  accessories. >



STRAIGHT AND ANGLED MULTI-UNIT ABUTMENT

Straight, 17° & 30°

Platform	Height (mm)	Straight	17°	30°
RP	1.5	IPD/QB-MR-01	-	-
	2.5	IPD/QB-MR-02	IPD/QB-MR-13	-
	3.5	IPD/QB-MR-03	-	IPD/QB-MR-34

Our straight multi-units can be used for single and multiple restorations. Please see page 198 for the Multi-unit system accessories. >



STRAIGHT AND ANGLED CASTABLE ABUTMENT WITH A Co-Cr BASE



Straight & 15°

Platform	Angulation		
RP	Straight	IPD/QB-BR-00	IPD/QB-BR-01
	15°	IPD/QB-BR-10	IPD/QB-BR-11

All angled castable abutments include a TPA screw.



Co-Cr 3D BASE / SCAN BODY

Platform				Scan Body
RP	Straight	IPD/QB-BR-00/3D	IPD/QB-BR-01/3D	IPD/SC-AN-B1



PSD OVERDENTURE ABUTMENT

Platform	Height (mm)	Reference
RP	2.0	IPD/QB-LR-02
	3.0	IPD/QB-LR-03
	4.0	IPD/QB-LR-04

Please see page 208 for the PSD system accessories. >



TEMPORARY ABUTMENT/ OPEN TRAY COPING

Platform			Coping screw
RP	IPD/QB-PR-06	IPD/QB-PR-07	IPD/QB-TR-00/C

The same abutment can be used as a temporary abutment with the occlusal screw or as an impression coping using the coping screw.



HEALING ABUTMENT

Platform	Height (mm)	Reference
RP	1.5	IPD/QB-DR-01
	3.0	IPD/QB-DR-03
	5.0	IPD/QB-DR-05



Compatibility
NEODENT®
RB Series
GRAND MORSE™ GM
[GM]

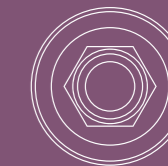



COMPATIBILITY
RB Series
[GM]

GRAND MORSE™ GM



COMPATIBILITY
RB Series
[GM]



ANALOG / DIGITAL ANALOG

Platform	Reference	Digital reference
GM	IPD/RB-AR-00	IPD/RB-AR-00/3D
Lower Screw	-	IPD/KA-TA-00
Transverse Screw	-	IPD/KA-TA-01



SCREW

Platform	Screwdriver	Seat	Reference	TiN Reference
GM	Neo GM	Conical	IPD/RB-TR-00	IPD/RB-TR-00/TiN

 Lengths 18/25/32 mm. Please see page 225 for more information. >





TPA SCREW FOR ANGLED PROSTHESIS

Platform	Screwdriver	Seat	Reference
GM	TPA	Conical	IPD/RB-TR-50

 Lengths 18/25/32 mm. Please see page 226 for more information. >





INTRA-ORAL / DESKTOP / CONTACT PROBE SCAN BODY

Platform	Height (mm)		
GM	10	IPD/RB-SR-00	IPD/RB-SR-01
	15	IPD/RB-SR-02	-

Captive screw included. 1.20 Hex Screwdriver.



Ti-BASE 

Platform	Height (mm)		
GM	1.0	IPD/RB-IR-00/3D	IPD/RB-IR-01/3D
	2.0	IPD/RB-IR-02/3D	IPD/RB-IR-03/3D
	3.0	IPD/RB-IR-04/3D	IPD/RB-IR-05/3D

Please see page 188 for the  accessories. >



STRAIGHT AND ANGLED MULTI-UNIT ABUTMENT

Straight, 17° & 30°

Platform	Height (mm)	Straight	17°	30°
GM	1.5	IPD/RB-MR-01	-	-
	2.5	IPD/RB-MR-02	IPD/RB-MR-12	-
	3.5	IPD/RB-MR-03	-	IPD/RB-MR-33

Our straight multi-units can be used for single and multiple restorations. Please see page 198 for the Multi-unit system accessories. >



STRAIGHT CASTABLE ABUTMENT WITH A Co-Cr BASE

Platform		
GM	IPD/RB-BR-00	IPD/RB-BR-01



Co-Cr 3D BASE / SCAN BODY

Platform	Straight / Angled			Scan Body
GM	IPD/RB-BR-00/3D	IPD/RB-BR-01/3D	IPD/SC-AN-B1	



PSD OVERDENTURE ABUTMENT

Platform	Height (mm)	Reference
GM	2.0	IPD/RB-LR-02
	3.0	IPD/RB-LR-03
	4.0	IPD/RB-LR-04

Please see page 208 for the PSD system accessories. >



TEMPORARY ABUTMENT/ OPEN TRAY COPING

Platform			Coping screw
GM	IPD/RB-PR-06	IPD/RB-PR-07	IPD/RB-TR-00/C

The same abutment can be used as a temporary abutment with the occlusal screw or as an impression coping using the coping screw.



HEALING ABUTMENT

Platform	Height (mm)	Reference
GM	1.5	IPD/RB-DR-01
	3.0	IPD/RB-DR-03
	5.0	IPD/RB-DR-05



Compatibility
BEGO® SEMADOS®

SB Series
SC/RS

[ϕ 3.25 / ϕ 3.75 / ϕ 4.1 / ϕ 4.5]





COMPATIBILITY
SB Series SC/RS
[ϕ 3.25 / ϕ 3.75 / ϕ 4.1 / ϕ 4.5]



COMPATIBILITY
SB Series SC/RS
[ϕ 3.25 / ϕ 3.75 / ϕ 4.1 / ϕ 4.5]



ANALOG / DIGITAL ANALOG

Platform	Reference	Digital reference
ϕ 3.25 ϕ 3.75	IPD/SB-AN-00	IPD/SB-AN-00/3D
ϕ 4.1	IPD/SB-AR-00	IPD/SB-AR-00/3D
ϕ 4.5	IPD/SB-AW-00	IPD/SB-AW-00/3D
Lower Screw	-	IPD/KA-TA-00
Transverse Screw	-	IPD/KA-TA-01



SCREW

Platform	Screwdriver	Seat	Reference	TiN Reference
ϕ 3.25 ϕ 3.75 ϕ 4.1 ϕ 4.5	1.25 Hex	Conical	IPD/SB-TR-00	IPD/SB-TR-00/TiN

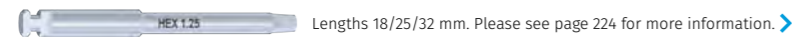

TPA SCREW FOR ANGLED PROSTHESIS

Platform	Screwdriver	Seat	Reference
ϕ 3.25 ϕ 3.75 ϕ 4.1 ϕ 4.5	TPA	Conical	IPD/SB-TR-50

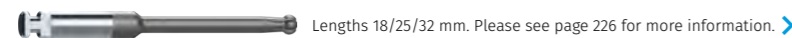

INTRA-ORAL / DESKTOP / CONTACT PROBE SCAN BODY

Platform	Height (mm)		
ϕ 3.25 ϕ 3.75	10	IPD/SB-SN-00	IPD/SB-SN-01
	15	IPD/SB-SN-02	-
ϕ 4.1	10	IPD/SB-SR-00	IPD/SB-SR-01
	15	IPD/SB-SR-02	-
ϕ 4.5	10	IPD/SB-SW-00	IPD/SB-SW-01
	15	IPD/SB-SW-02	-

Captive screw included. 1.20 Hex Screwdriver.



Ti-BASE

Platform	Height (mm)		
ϕ 3.25 ϕ 3.75	0.5	IPD/SB-IN-00/3D	IPD/SB-IN-01/3D
	1.5	IPD/SB-IN-02/3D	IPD/SB-IN-03/3D
	2.5	IPD/SB-IN-04/3D	IPD/SB-IN-05/3D
ϕ 4.1	0.5	IPD/SB-IR-00/3D	IPD/SB-IR-01/3D
	1.5	IPD/SB-IR-02/3D	IPD/SB-IR-03/3D
	2.5	IPD/SB-IR-04/3D	IPD/SB-IR-05/3D
ϕ 4.5	0.5	IPD/SB-IW-00/3D	IPD/SB-IW-01/3D
	1.5	IPD/SB-IW-02/3D	IPD/SB-IW-03/3D
	2.5	IPD/SB-IW-04/3D	IPD/SB-IW-05/3D

Please see page 188 for the accessories. >



STRAIGHT AND ANGLED MULTI-UNIT ABUTMENT

Straight, 17° & 30°

Platform	Height (mm)	Straight	17°	30°
ϕ 3.25 ϕ 3.75	1.5	IPD/SB-MN-01	-	-
	2.5	IPD/SB-MN-02	IPD/SB-MN-12	-
	3.5	IPD/SB-MN-03	IPD/SB-MN-13	IPD/SB-MN-33
	4.5	IPD/SB-MN-04	-	IPD/SB-MN-34
	5.5	IPD/SB-MN-05	-	-
ϕ 4.1	1.5	IPD/SB-MR-01	-	-
	2.5	IPD/SB-MR-02	IPD/SB-MR-12	-
	3.5	IPD/SB-MR-03	-	IPD/SB-MR-33
	4.5	IPD/SB-MR-04	-	-
ϕ 4.5	1.5	IPD/SB-MW-01	-	-
	2.5	IPD/SB-MW-02	IPD/SB-MW-12	-
	3.5	-	-	IPD/SB-MW-33



Our straight multi-units can be used for single and multiple restorations. Please see page 198 for the Multi-unit system accessories. >

STRAIGHT AND ANGLED CASTABLE ABUTMENT WITH A Co-Cr BASE

Straight, 15° & 25°

Platform	Angulation		
ϕ 3.25 ϕ 3.75	Straight	IPD/SB-BN-00	IPD/SB-BN-01
	15°	IPD/SB-BN-10	IPD/SB-BN-11
	25°	IPD/SB-BN-20	IPD/SB-BN-21
ϕ 4.1	Straight	IPD/SB-BR-00	IPD/SB-BR-01
	15°	IPD/SB-BR-10	IPD/SB-BR-11
	25°	IPD/SB-BR-20	IPD/SB-BR-21
ϕ 4.5	Straight	IPD/SB-BW-00	IPD/SB-BW-01
	15°	IPD/SB-BW-10	IPD/SB-BW-11
	25°	IPD/SB-BW-20	IPD/SB-BW-21



All angled castable abutments include a TPA screw.

Co-Cr 3D BASE / SCAN BODY

Platform				Scan Body
ϕ 3.25 ϕ 3.75	Straight / Angled	IPD/SB-BN-00/3D	IPD/SB-BN-01/3D	IPD/SC-AN-B1
ϕ 4.1	Straight / Angled	IPD/SB-BR-00/3D	IPD/SB-BR-01/3D	IPD/SC-AN-B1
ϕ 4.5	Straight / Angled	IPD/SB-BW-00/3D	IPD/SB-BW-01/3D	IPD/SC-AN-B1





COMPATIBILITY
SB Series SC/RS
[ϕ 3.25 / ϕ 3.75 / ϕ 4.1 / ϕ 4.5]





PSD OVERDENTURE ABUTMENT

Platform	Height (mm)	Reference
ϕ 3.25 ϕ 3.75	1.0	IPD/SB-LN-01
	2.0	IPD/SB-LN-02
	3.0	IPD/SB-LN-03
	4.0	IPD/SB-LN-04
	5.0	IPD/SB-LN-05
ϕ 4.1	1.0	IPD/SB-LR-01
	2.0	IPD/SB-LR-02
	3.0	IPD/SB-LR-03
	4.0	IPD/SB-LR-04
	5.0	IPD/SB-LR-05
ϕ 4.5	1.0	IPD/SB-LW-01
	2.0	IPD/SB-LW-02
	3.0	IPD/SB-LW-03
	4.0	IPD/SB-LW-04
	5.0	IPD/SB-LW-05

Please see page 208 for the PSD system accessories. >

TEMPORARY ABUTMENT/ OPEN TRAY COPING

Platform			Coping screw
ϕ 3.25 ϕ 3.75	IPD/SB-PN-06	IPD/SB-PN-07	
ϕ 4.1	IPD/SB-PR-06	IPD/SB-PR-07	IPD/SB-TR-00/C
ϕ 4.5	IPD/SB-PW-06	IPD/SB-PW-07	

The same abutment can be used as a temporary abutment with the occlusal screw or as an impression coping using the coping screw.

HEALING ABUTMENT

Platform	Height (mm)	Reference
ϕ 3.25 ϕ 3.75	3.0	IPD/SB-DN-03
	5.0	IPD/SB-DN-05
	7.0	IPD/SB-DN-07
ϕ 4.1	3.0	IPD/SB-DR-03
	5.0	IPD/SB-DR-05
	7.0	IPD/SB-DR-07
ϕ 4.5	3.0	IPD/SB-DW-03
	5.0	IPD/SB-DW-05
	7.0	IPD/SB-DW-07



Compatibility
MIS®
TA Series SEVEN®
[Narrow 3.3 / Standard / Wide]

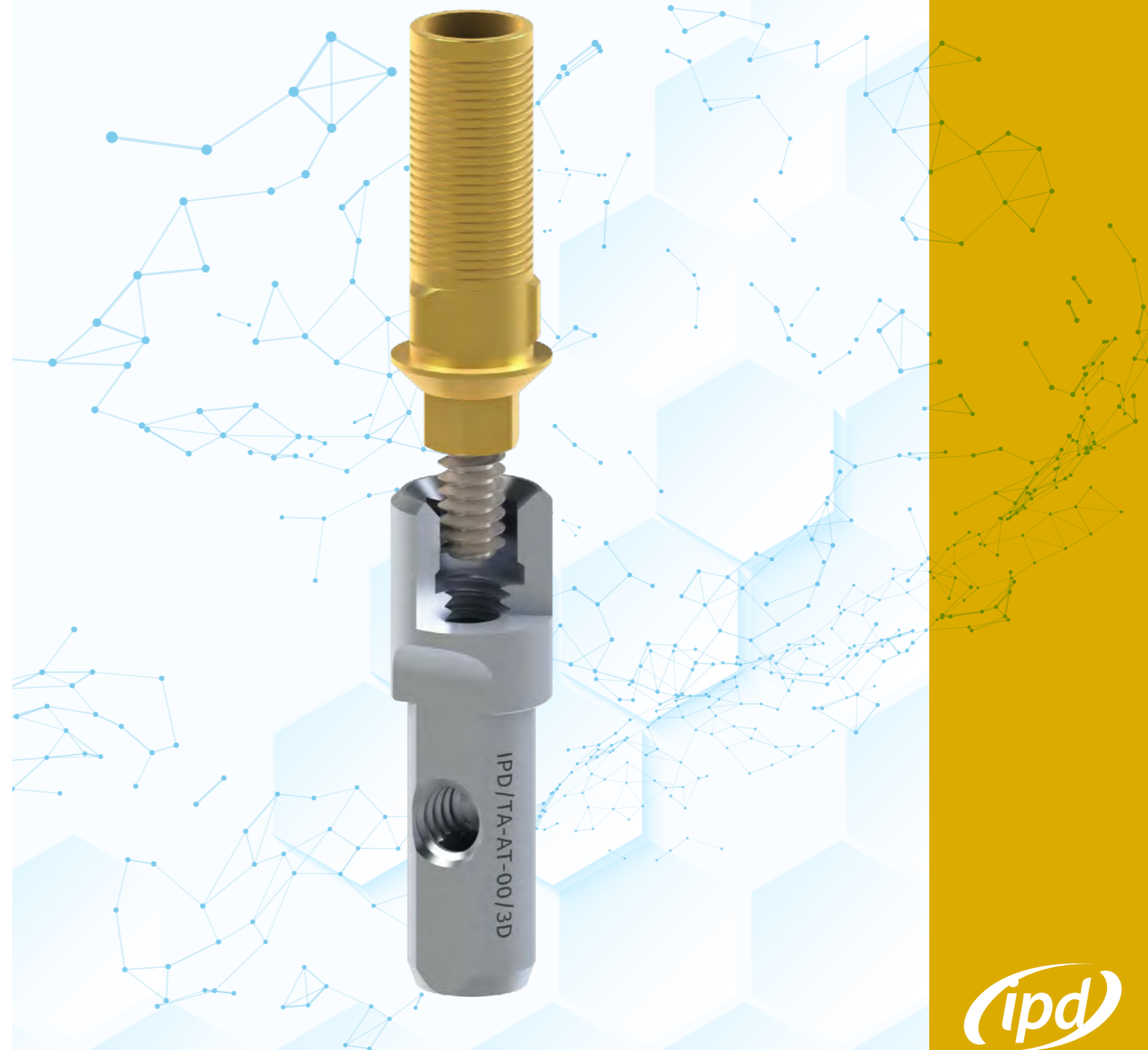



ANALOG / DIGITAL ANALOG

Platform	Reference	Digital reference
Narrow 3.3	IPD/TA-AT-00	IPD/TA-AT-00/3D
Standard	IPD/FA-AN-00	IPD/FA-AN-00/3D
Wide	IPD/FA-AR-00	IPD/FA-AR-00/3D
Lower Screw	-	IPD/KA-TA-00
Transverse Screw	-	IPD/KA-TA-01



SCREW

Platform	Screwdriver	Seat	Reference	TiN Reference
Narrow 3.3	1.25 Hex	Conical	IPD/TA-TT-00	IPD/TA-TT-00/TiN
Standard / Wide	1.25 Hex	Conical	IPD/FA-TR-00	IPD/FA-TR-00/TiN

 HEX 1.25 Lengths 18/25/32 mm. Please see page 224 for more information. >

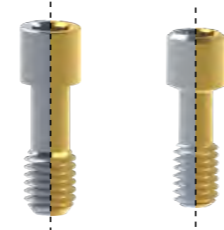



TPA SCREW FOR ANGLED PROSTHESIS

Platform	Screwdriver	Seat	Reference
Narrow 3.3	TPA	Conical	IPD/TA-TT-50
Standard / Wide	TPA	Conical	IPD/FA-TR-50

 Lengths 18/25/32 mm. Please see page 226 for more information. >





INTRA-ORAL / DESKTOP / CONTACT PROBE SCAN BODY

Platform	Height (mm)		
Narrow 3.3	10	IPD/TA-ST-00	IPD/TA-ST-01
	15	IPD/TA-ST-02	-
Standard	10	IPD/FA-SN-00	IPD/FA-SN-01
	15	IPD/FA-SN-02	-
Wide	10	IPD/FA-SR-00	IPD/FA-SR-01
	15	IPD/FA-SR-02	-

Captive screw included. 1.20 Hex Screwdriver.



Ti-BASE

Platform	Height (mm)		
Narrow 3.3	0.5	IPD/TA-IT-00/3D	IPD/TA-IT-01/3D
	1.5	IPD/TA-IT-02/3D	IPD/TA-IT-03/3D
	2.5	IPD/TA-IT-04/3D	IPD/TA-IT-05/3D
Standard	0.5	IPD/FA-IN-00/3D	IPD/FA-IN-01/3D
	1.5	IPD/FA-IN-02/3D	IPD/FA-IN-03/3D
	2.5	IPD/FA-IN-04/3D	IPD/FA-IN-05/3D
Wide	0.5	IPD/FA-IR-00/3D	IPD/FA-IR-01/3D
	1.5	IPD/FA-IR-02/3D	IPD/FA-IR-03/3D
	2.5	IPD/FA-IR-04/3D	IPD/FA-IR-05/3D

High version of the non-engaging Custom Ti-Base subject to availability. Please see page 188 for the  accessories. >



STRAIGHT AND ANGLED MULTI-UNIT ABUTMENT

Straight, 17° & 30°



Platform	Height (mm)	Straight	17°	30°
Standard	0.9	IPD/FA-MN-00	-	-
	1.5	IPD/FA-MN-01	-	-
	2.5	IPD/FA-MN-02	IPD/FA-MN-12	-
	3.5	IPD/FA-MN-03	IPD/FA-MN-13	IPD/FA-MN-33
	4.5	IPD/FA-MN-04	-	IPD/FA-MN-34
Wide	1.5	IPD/FA-MR-01	-	-
	2.5	IPD/FA-MR-02	-	-
	3.0	-	IPD/FA-MR-13	-
	3.5	IPD/FA-MR-03	-	IPD/FA-MR-33
	4.0	-	IPD/FA-MR-14	-
	4.5	IPD/FA-MR-04	-	IPD/FA-MR-34



Our straight multi-units can be used for single and multiple restorations. Please see page 198 for the Multi-unit system accessories. >

STRAIGHT AND ANGLED CASTABLE ABUTMENT WITH A Co-Cr BASE

Straight, 15° & 25°

Platform	Angulation		
Narrow 3.3	Straight	IPD/TA-BT-00	IPD/TA-BT-01
	15°	IPD/TA-BT-10	IPD/TA-BT-11
	25°	IPD/TA-BT-20	IPD/TA-BT-21
Standard	Straight	IPD/FA-BN-00	IPD/FA-BN-01
	15°	IPD/FA-BN-10	IPD/FA-BN-11
	25°	IPD/FA-BN-20	IPD/FA-BN-21
Wide	Straight	IPD/FA-BR-00	IPD/FA-BR-01
	15°	IPD/FA-BR-10	IPD/FA-BR-11
	25°	IPD/FA-BR-20	IPD/FA-BR-21



All angled castable abutments include a TPA screw.



Co-Cr 3D BASE / SCAN BODY

Platform				Scan Body
Narrow 3.3	Straight / Angled	IPD/TA-BT-00/3D	IPD/TA-BT-01/3D	IPD/SC-AN-B1
Standard	Straight / Angled	IPD/FA-BN-00/3D	IPD/FA-BN-01/3D	IPD/SC-AN-B1
Wide	Straight	IPD/FA-BR-00/3D	IPD/FA-BR-01/3D	IPD/SC-AN-B1
	Angled	IPD/FA-BR-A0/3D	IPD/FA-BR-A1/3D	IPD/SC-AN-B1



PSD OVERDENTURE ABUTMENT

Platform	Height (mm)	Reference
Narrow 3.3	1.0	IPD/TA-LT-01
	2.0	IPD/TA-LT-02
	3.0	IPD/TA-LT-03
	4.0	IPD/TA-LT-04
	5.0	IPD/TA-LT-05
Standard	1.0	IPD/FA-LN-01
	2.0	IPD/FA-LN-02
	3.0	IPD/FA-LN-03
	4.0	IPD/FA-LN-04
	5.0	IPD/FA-LN-05
Wide	1.0	IPD/FA-LR-01
	2.0	IPD/FA-LR-02
	3.0	IPD/FA-LR-03
	4.0	IPD/FA-LR-04
	5.0	IPD/FA-LR-05



Please see page 208 for the PSD system accessories. >

TEMPORARY ABUTMENT/ OPEN TRAY COPING

Platform			Coping screw
Narrow 3.3	IPD/TA-PT-06	IPD/TA-PT-07	IPD/TA-TT-00/C
Standard	IPD/FA-PN-06	IPD/FA-PN-07	IPD/FA-TR-00/C
Wide	IPD/FA-PR-06	IPD/FA-PR-07	IPD/FA-TR-00/C

The same abutment can be used as a temporary abutment with the occlusal screw or as an impression coping using the coping screw.

OPEN TRAY COPING

Platform	Referencia
Standard	Open tray coping IPD/FA-CN-00

Classic design.



HEALING ABUTMENT

Platform	Height (mm)	Reference
Narrow 3.3	2.0	IPD/TA-DT-02
	3.0	IPD/TA-DT-03
	4.0	IPD/TA-DT-04
	5.0	IPD/TA-DT-05
	1.5	IPD/FA-DN-01
Standard	3.0	IPD/FA-DN-03
	5.0	IPD/FA-DN-05
	1.5	IPD/FA-DR-01
Wide	3.0	IPD/FA-DR-03
	5.0	IPD/FA-DR-05



STRAIGHT AND ANGLED ABUTMENT

Platform	Height (mm)	Angulation	Reference
Standard	1.0	Straight	IPD/FA-PN-00
		15°	IPD/FA-PN-02
		25°	IPD/FA-PN-04
	2.0	Straight	IPD/FA-PN-01
		15°	IPD/FA-PN-03
		25°	IPD/FA-PN-05



CASTABLE

Platform		
Standard	IPD/FA-HN-00	IPD/FA-RN-00
Wide	IPD/FA-HR-00	IPD/FA-RR-00



Compatibility

MIS®

TB Series

C1 / V3®

[Standard]

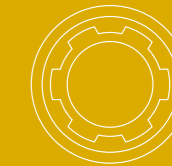



ANALOG / DIGITAL ANALOG

Platform	Reference	Digital reference
Standard	IPD/TB-AR-00	IPD/TB-AR-00/3D
Lower Screw	-	IPD/KA-TA-00
Transverse Screw	-	IPD/KA-TA-01



SCREW

Platform	Screwdriver	Seat	Reference	TiN Reference
Standard	1.25 Hex	Conical	IPD/TB-TR-00	IPD/TB-TR-00/TIN

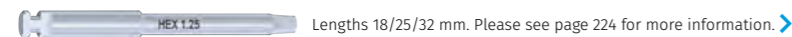

TPA SCREW FOR ANGLED PROSTHESIS

Platform	Screwdriver	Seat	Reference
Standard	TPA	Conical	IPD/TB-TR-50

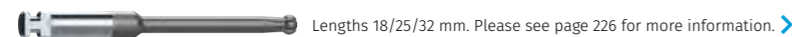

INTRA-ORAL / DESKTOP / CONTACT PROBE SCAN BODY

Platform	Height (mm)		
Standard	10	IPD/TB-SR-00	IPD/TB-SR-01
	15	IPD/TB-SR-02	-

Captive screw included. 1.20 Hex Screwdriver.



Ti-BASE

Platform	Height (mm)		
Standard	0.7	IPD/TB-IR-00/3D	IPD/TB-IR-01/3D
	1.5	IPD/TB-IR-02/3D	IPD/TB-IR-03/3D
	2.5	IPD/TB-IR-04/3D	IPD/TB-IR-05/3D
	3.5	IPD/TB-IR-06/3D	IPD/TB-IR-07/3D

High version of the non-engaging Custom Ti-Base subject to availability. Please see page 188 for the accessories. >



STRAIGHT AND ANGLED MULTI-UNIT ABUTMENT

Straight, 17° & 30°

Platform	Height (mm)	Straight	17°	30°
Standard	1.0	IPD/TB-MR-01	-	-
	2.0	IPD/TB-MR-02	-	-
	2.5	-	IPD/TB-MR-12	-
	3.0	IPD/TB-MR-03	-	-
	3.5	-	-	IPD/TB-MR-33
	4.0	IPD/TB-MR-04	-	-

Our straight multi-units can be used for single and multiple restorations. Please see page 198 for the Multi-unit system accessories. >



STRAIGHT AND ANGLED CASTABLE ABUTMENT WITH A Co-Cr BASE

Straight, 15° & 25°

Platform	Angulation		
Standard	Straight	IPD/TB-BR-00	IPD/TB-BR-01
	15°	IPD/TB-BR-10	IPD/TB-BR-11
	25°	IPD/TB-BR-20	IPD/TB-BR-21

All angled castable abutments include a TPA screw.



Co-Cr 3D BASE / SCAN BODY

Platform				Scan Body
Standard	Straight / Angled	IPD/TB-BR-00/3D	IPD/TB-BR-01/3D	IPD/SC-AN-B1



PSD OVERDENTURE ABUTMENT

Platform	Height (mm)	Reference
Standard	1.0	IPD/TB-LR-01
	2.0	IPD/TB-LR-02
	3.0	IPD/TB-LR-03
	4.0	IPD/TB-LR-04
	5.0	IPD/TB-LR-05

Please see page 208 for the PSD system accessories. >







COMPATIBILITY
TB Series C1 / V3®
[Standard]



TEMPORARY ABUTMENT/ OPEN TRAY COPING

Platform			Coping screw
Standard	IPD/TB-PR-06	IPD/TB-PR-07	IPD/TB-TR-00/C

The same abutment can be used as a temporary abutment with the occlusal screw or as an impression coping using the coping screw.



HEALING ABUTMENT

Platform	Height (mm)	Reference
Standard	2.0	IPD/TB-DR-02
	3.0	IPD/TB-DR-03
	4.0	IPD/TB-DR-04
	5.0	IPD/TB-DR-05

Compatibility

DIO®

UB Series

UFII

[NP / RP]





ANALOG / DIGITAL ANALOG

Platform	Reference	Digital reference
NP	IPD/UB-AN-00	IPD/UB-AN-00/3D
RP	IPD/UB-AR-00	IPD/UB-AR-00/3D
Lower Screw	-	IPD/KA-TA-00
Transverse Screw	-	IPD/KA-TA-01



SCREW

Platform	Screwdriver	Seat	Reference	TiN Reference
NP	1.20 Hex	Conical	IPD/UB-TN-00	IPD/UB-TN-00/TIN
RP	1.20 Hex	Conical	IPD/UB-TR-00	IPD/UB-TR-00/TIN

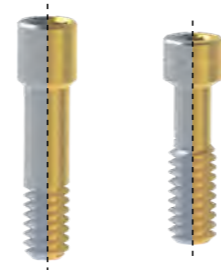

TPA SCREW FOR ANGLED PROSTHESIS

Platform	Screwdriver	Seat	Reference
NP	TPA	Conical	IPD/UB-TN-50
RP	TPA	Conical	IPD/UB-TR-50



INTRA-ORAL / DESKTOP / CONTACT PROBE SCAN BODY

Platform	Height (mm)		
NP	10	IPD/UB-SN-00	IPD/UB-SN-01
	15	IPD/UB-SN-02	-
RP	10	IPD/UB-SR-00	IPD/UB-SR-01
	15	IPD/UB-SR-02	-

Captive screw included. 1.20 Hex Screwdriver.



Ti-BASE Custom Interface System

Platform	Height (mm)		
NP	1.0	IPD/UB-IN-00/3D	IPD/UB-IN-01/3D
	2.0	IPD/UB-IN-02/3D	IPD/UB-IN-03/3D
	3.0	IPD/UB-IN-04/3D	IPD/UB-IN-05/3D
RP	1.0	IPD/UB-IR-00/3D	IPD/UB-IR-01/3D
	2.0	IPD/UB-IR-02/3D	IPD/UB-IR-03/3D
	3.0	IPD/UB-IR-04/3D	IPD/UB-IR-05/3D

Please see page 188 for the Custom Interface System[®] accessories. >



STRAIGHT AND ANGLED MULTI-UNIT ABUTMENT

Straight, 17° & 30°

Platform	Height (mm)	Straight	17°	30°
NP	1.5	IPD/UB-MN-01	-	-
	2.5	IPD/UB-MN-02	IPD/UB-MN-12	-
	3.5	IPD/UB-MN-03	-	IPD/UB-MN-33
RP	1.5	IPD/UB-MR-01	-	-
	2.5	IPD/UB-MR-02	IPD/UB-MR-12	-
	3.5	IPD/UB-MR-03	-	IPD/UB-MR-33



Our straight multi-units can be used for single and multiple restorations. Please see page 198 for the Multi-unit system accessories. >

STRAIGHT AND ANGLED CASTABLE ABUTMENT WITH A Co-Cr BASE

Straight & 15°

Platform	Angulation		
NP	Straight	IPD/UB-BN-00	IPD/UB-BN-01
	15°	IPD/UB-BN-10	IPD/UB-BN-11
RP	Straight	IPD/UB-BR-00	IPD/UB-BR-01



Co-Cr 3D BASE / SCAN BODY

Platform	Angulation			Scan Body
NP	Straight / Angled	IPD/UB-BN-00/3D	IPD/UB-BN-01/3D	IPD/SC-AN-B1
RP	Straight / Angled	IPD/UB-BR-00/3D	IPD/UB-BR-01/3D	IPD/SC-AN-B1



PSD OVERDENTURE ABUTMENT

Platform	Height (mm)	Reference
NP	2.0	IPD/UB-LN-02
	3.0	IPD/UB-LN-03
	4.0	IPD/UB-LN-04
	2.0	IPD/UB-LR-02
RP	3.0	IPD/UB-LR-03
	4.0	IPD/UB-LR-04





Please see page 208 for the PSD system accessories. >



COMPATIBILITY
UB Series **UFII**
[NP / RP]



TEMPORARY ABUTMENT/ OPEN TRAY COPING

Platform			Coping screw
NP	IPD/UB-PN-06	IPD/UB-PN-07	IPD/UB-TN-00/C
RP	IPD/UB-PR-06	IPD/UB-PR-07	IPD/UB-TR-00/C

The same abutment can be used as a temporary abutment with the occlusal screw or as an impression coping using the coping screw.



HEALING ABUTMENT

Platform	Height (mm)	Reference
NP	2.0	IPD/UB-DN-02
	3.5	IPD/UB-DN-03
	5.0	IPD/UB-DN-05
RP	2.0	IPD/UB-DR-02
	3.5	IPD/UB-DR-03
	5.0	IPD/UB-DR-05

Compatibility
MEGAGEN®

WA Series
ANYONE®
[RP]

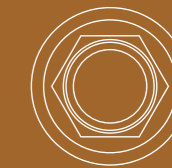



COMPATIBILITY
WA Series ANYONE®
[RP]



COMPATIBILITY
WA Series ANYONE®
[RP]



ANALOG / DIGITAL ANALOG

Platform	Reference	Digital reference
RP	IPD/WA-AR-00	IPD/WA-AR-00/3D
Lower Screw	-	IPD/KA-TA-00
Transverse Screw	-	IPD/KA-TA-01



SCREW

Platform	Screwdriver	Seat	Reference	TiN Reference
RP	1.20 Hex	Conical	IPD/WA-TR-00	IPD/WA-TR-00/TiN

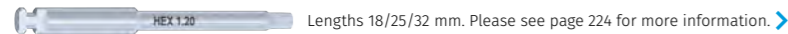



TPA SCREW FOR ANGLED PROSTHESIS

Platform	Screwdriver	Seat	Reference
RP	TPA	Conical	IPD/WA-TR-50





INTRA-ORAL / DESKTOP / CONTACT PROBE SCAN BODY

Platform	Height (mm)		
RP	10	IPD/WA-SR-00	IPD/WA-SR-01
	15	IPD/WA-SR-02	-

Captive screw included. 1.20 Hex Screwdriver.



Ti-BASE

Platform	Height (mm)		
RP	1.0	IPD/WA-IR-00/3D	IPD/WA-IR-01/3D
	2.0	IPD/WA-IR-02/3D	IPD/WA-IR-03/3D
	3.0	IPD/WA-IR-04/3D	IPD/WA-IR-05/3D

Please see page 188 for the  accessories. >



STRAIGHT AND ANGLED MULTI-UNIT ABUTMENT

Straight, 17° & 30°

Platform	Height (mm)	Straight	17°	30°
RP	1.5	IPD/WA-MR-01	-	-
	2.5	IPD/WA-MR-02	IPD/WA-MR-12	-
	3.5	IPD/WA-MR-03	-	IPD/WA-MR-33

Our straight multi-units can be used for single and multiple restorations. Please see page 198 for the Multi-unit system accessories. >



STRAIGHT CASTABLE ABUTMENT WITH A Co-Cr BASE

Platform		
RP	IPD/WA-BR-00	IPD/WA-BR-01



Co-Cr 3D BASE / SCAN BODY

Platform	Straight / Angled			Scan Body
RP		IPD/WA-BR-00/3D	IPD/WA-BR-01/3D	IPD/SC-AN-B1



PSD OVERDENTURE ABUTMENT

Platform	Height (mm)	Reference
RP	2.0	IPD/WA-LR-02
	3.0	IPD/WA-LR-03
	4.0	IPD/WA-LR-04

Please see page 208 for the PSD system accessories. >



TEMPORARY ABUTMENT/ OPEN TRAY COPING

Platform			Coping screw
RP	IPD/WA-PR-06	IPD/WA-PR-07	IPD/WA-TR-00/C

The same abutment can be used as a temporary abutment with the occlusal screw or as an impression coping using the coping screw.





COMPATIBILITY
WA Series ANYONE®
 [RP]



HEALING ABUTMENT

Platform	Height (mm)	Reference
	3.0	IPD/WA-DR-03
RP	5.0	IPD/WA-DR-05
	7.0	IPD/WA-DR-07



Compatibility
MEGAGEN®

WB Series ANYRIDGE®
 [Ø4.0]

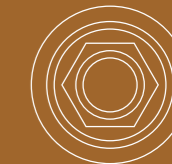



ANALOG / DIGITAL ANALOG

Platform	Reference	Digital reference
ø4.0	IPD/WB-AR-00	IPD/WB-AR-00/3D
Lower Screw	-	IPD/KA-TA-00
Transverse Screw	-	IPD/KA-TA-01



SCREW

Platform	Screwdriver	Seat	Reference	TiN Reference
ø4.0	1.20 Hex	Flat	IPD/WB-TR-00	IPD/WB-TR-00/TIN
			IPD/WB-TR-01	-

The IPD/WB-TR-01 model is an abutment extractor screw.



INTRA-ORAL / DESKTOP / CONTACT PROBE SCAN BODY

Platform	Height (mm)		
ø4.0	10	IPD/WB-SR-00	IPD/WB-SR-01
	15	IPD/WB-SR-02	-

Captive screw included. 1.20 Hex Screwdriver.



Ti-BASE

Platform	Height (mm)		
ø4.0	1.0	IPD/WB-IR-00/3D	IPD/WB-IR-01/3D
	2.0	IPD/WB-IR-02/3D	IPD/WB-IR-03/3D
	3.0	IPD/WB-IR-04/3D	IPD/WB-IR-05/3D

Please see page 188 for the Custom Interface System® accessories. >



STRAIGHT AND ANGLED MULTI-UNIT ABUTMENT

Platform	Height (mm)	Straight	17°	30°
ø4.0	1.5	IPD/WB-MR-01	-	-
	2.5	IPD/WB-MR-02	IPD/WB-MR-12	-
	3.5	IPD/WB-MR-03	-	IPD/WB-MR-33

Our straight multi-units can be used for single and multiple restorations. Please see page 198 for the Multi-unit system accessories. >



STRAIGHT CASTABLE ABUTMENT WITH A Co-Cr BASE

Platform		
ø4.0	IPD/WB-BR-00	IPD/WB-BR-01



Co-Cr 3D BASE / SCAN BODY

Platform				Scan Body
ø4.0	Straight	IPD/WB-BR-00/3D	IPD/WB-BR-01/3D	IPD/SC-AN-B1



PSD OVERDENTURE ABUTMENT

Platform	Height (mm)	Reference
ø4.0	2.0	IPD/WB-LR-02
	3.0	IPD/WB-LR-03
	4.0	IPD/WB-LR-04

Please see page 208 for the PSD system accessories. >



TEMPORARY ABUTMENT/ OPEN TRAY COPING

Platform			Coping screw
ø4.0	IPD/WB-PR-06	IPD/WB-PR-07	IPD/WB-TR-00/C

The same abutment can be used as a temporary abutment with the occlusal screw or as an impression coping using the coping screw.



HEALING ABUTMENT

Platform	Height (mm)	Reference
ø4.0	1.5	IPD/WB-DR-01
	3.0	IPD/WB-DR-03
	5.0	IPD/WB-DR-05



Compatibility
DENTIUM®

XA Series
IMPLANTIUM® / SUPERLINE™
[RP]

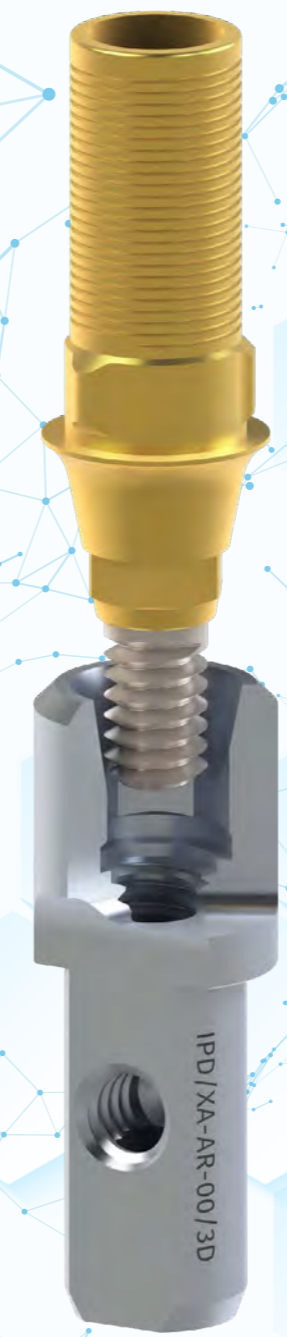



ANALOG / DIGITAL ANALOG

Platform	Reference	Digital reference
RP	IPD/XA-AR-00	IPD/XA-AR-00/3D
Lower Screw	-	IPD/KA-TA-00
Transverse Screw	-	IPD/KA-TA-01



SCREW

Platform	Screwdriver	Seat	Reference	TiN Reference
RP	1.27 Hex	Conical	IPD/XA-TR-00	IPD/XA-TR-00/TIN



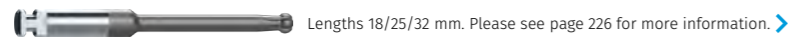

TPA SCREW FOR ANGLED PROSTHESIS

Platform	Screwdriver	Seat	Reference
RP	TPA	Conical	IPD/XA-TR-50





INTRA-ORAL / DESKTOP / CONTACT PROBE SCAN BODY

Platform	Height (mm)		
RP	10	IPD/XA-SR-00	IPD/XA-SR-01
	15	IPD/XA-SR-02	-

Captive screw included. 1.20 Hex Screwdriver.



Ti-BASE 

Platform	Height (mm)		
RP	1.0	IPD/XA-IR-00/3D	IPD/XA-IR-01/3D
	2.0	IPD/XA-IR-02/3D	IPD/XA-IR-03/3D
	3.0	IPD/XA-IR-04/3D	IPD/XA-IR-05/3D

High version of the non-engaging Custom Ti-Base subject to availability. Please see page 188 for the  accessories. >



STRAIGHT AND ANGLED MULTI-UNIT ABUTMENT

Straight, 17° & 30°

Platform	Height (mm)	Straight	17°	30°
RP	1.5	IPD/XA-MR-01	-	-
	2.5	IPD/XA-MR-02	IPD/XA-MR-12	-
	3.5	IPD/XA-MR-03	-	IPD/XA-MR-33

Our straight multi-units can be used for single and multiple restorations. Please see page 198 for the Multi-unit system accessories. >





STRAIGHT CASTABLE ABUTMENT WITH A Co-Cr BASE

Platform		
RP	IPD/XA-BR-00	IPD/XA-BR-01



Co-Cr 3D BASE / SCAN BODY

Platform	Straight / Angled			Scan Body
RP		IPD/XA-BR-00/3D	IPD/XA-BR-01/3D	IPD/SC-AN-B1



PSD OVERDENTURE ABUTMENT

Platform	Height (mm)	Reference
RP	2.0	IPD/XA-LR-02
	3.0	IPD/XA-LR-03
	4.0	IPD/XA-LR-04

Please see page 208 for the PSD system accessories. >



TEMPORARY ABUTMENT/ OPEN TRAY COPING

Platform			Coping screw
RP	IPD/XA-PR-06	IPD/XA-PR-07	IPD/XA-TR-00/C

The same abutment can be used as a temporary abutment with the occlusal screw or as an impression coping using the coping screw.



HEALING ABUTMENT

Platform	Height (mm)	Reference
RP	2.0	IPD/XA-DR-02
	3.5	IPD/XA-DR-03
	5.0	IPD/XA-DR-05



Compatibility
MEDENTIS®

Serie **YB**
ICX
[RP]

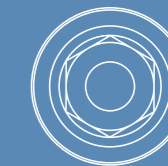



ANALOG / DIGITAL ANALOG

Platform	Reference	Digital reference
RP	IPD/YB-AR-00	IPD/YB-AR-00/3D
Lower Screw	-	IPD/KA-TA-00
Transverse Screw	-	IPD/KA-TA-01

SCREW

Platform	Screwdriver	Seat	Reference	TiN Reference
RP	1.40 Hex	Conical	IPD/YB-TR-00	IPD/YB-TR-00/TIN

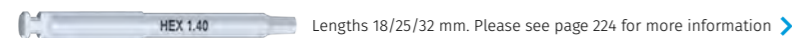

TPA SCREW FOR ANGLED PROSTHESIS

Platform	Screwdriver	Seat	Reference
RP	TPA	Conical	IPD/YB-TR-50

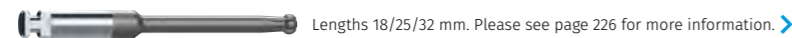

INTRA-ORAL / DESKTOP / CONTACT PROBE SCAN BODY

Platform	Height (mm)		
RP	10	IPD/YB-SR-00	IPD/YB-SR-01
	15	IPD/YB-SR-02	-

Captive screw included. 1.20 Hex Screwdriver.

Ti-BASE Custom Interface System®

Platform	Height (mm)		
RP	1.0	IPD/YB-IR-00/3D	IPD/YB-IR-01/3D
	2.0	IPD/YB-IR-02/3D	IPD/YB-IR-03/3D
	3.0	IPD/YB-IR-04/3D	IPD/YB-IR-05/3D

Please see page 188 for the Custom Interface System® accessories. >

STRAIGHT AND ANGLED MULTI-UNIT ABUTMENT

Straight, 17° & 30°

Platform	Height (mm)	Straight	17°	30°
RP	1.5	IPD/YB-MR-01	-	-
	2.5	IPD/YB-MR-02	IPD/YB-MR-12	-
	3.5	IPD/YB-MR-03	-	IPD/YB-MR-33

Our straight multi-units can be used for single and multiple restorations. Please see page 198 for the Multi-unit system accessories. >

STRAIGHT AND ANGLED CASTABLE ABUTMENT WITH A Co-Cr BASE

Platform	Angulation		
RP	Straight	IPD/YB-BR-00	IPD/YB-BR-01
	15°	IPD/YB-BR-10	IPD/YB-BR-11
	25°	IPD/YB-BR-20	IPD/YB-BR-21



Co-Cr 3D BASE / SCAN BODY

Platform	Angulation			Scan Body
RP	Straight / Angled	IPD/YB-BR-00/3D	IPD/YB-BR-01/3D	IPD/SC-AN-B1



PSD OVERDENTURE ABUTMENT

Platform	Height (mm)	Reference
RP	2.0	IPD/YB-LR-02
	3.0	IPD/YB-LR-03
	4.0	IPD/YB-LR-04

Please see page 208 for the PSD system accessories. >



TEMPORARY ABUTMENT/ OPEN TRAY COPING

Platform			Coping screw
RP	IPD/YB-PR-06	IPD/YB-PR-07	IPD/YB-TR-00/C

The same abutment can be used as a temporary abutment with the occlusal screw or as an impression coping using the coping screw.



HEALING ABUTMENT

Platform	Height (mm)	Reference
RP	1.0	IPD/YB-DR-01
	2.5	IPD/YB-DR-02
	4.0	IPD/YB-DR-04



-  Custom Interface System >
- MULTI-UNIT SYSTEM >
- PSD SYSTEM >
-  Hollow Screw System >
- ACCESSORIES >
- TECHNICAL SPECIFICATIONS >

WOKRFLOW DIAGRAM

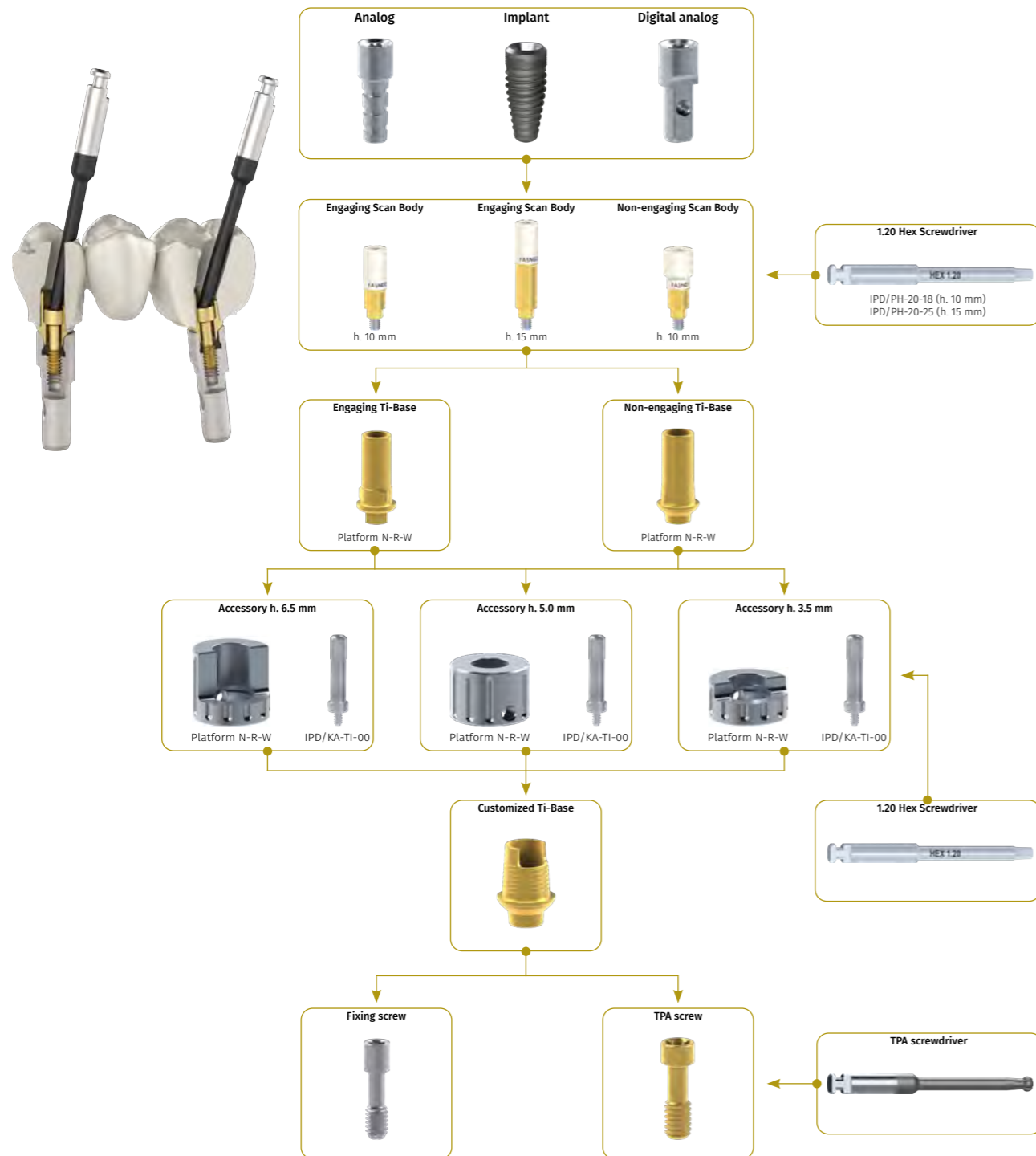

CUTTING GUIDE

Engaging

Platform	Height (mm)	Reference
Narrow	3.5	IPD/KA-IN-35
	5.0	IPD/KA-IN-50
	6.5	IPD/KA-IN-65
Standard	3.5	IPD/KA-IR-35
	5.0	IPD/KA-IR-50
	6.5	IPD/KA-IR-65
Wide	3.5	IPD/KA-IW-35
	5.0	IPD/KA-IW-50
	6.5	IPD/KA-IW-65

Version with agulation window subject to availability.

Non-engaging



Platform	Height (mm)	Reference
Narrow	3.5	IPD/KR-IN-35
	5.0	IPD/KR-IN-50
	6.5	IPD/KR-IN-65
Standard	3.5	IPD/KR-IR-35
	5.0	IPD/KR-IR-50
	6.5	IPD/KR-IR-65
Wide	3.5	IPD/KR-IW-35
	5.0	IPD/KR-IW-50
	6.5	IPD/KR-IW-65

Version with agulation window subject to availability.

FIXING SCREW

	Screwdriver	Reference
Every cutting guide	1.20 Hex	IPD/KA-TI-00

CUTTING GUIDE KITS

Platform	Heights (mm)		
Narrow	3.5 / 5.0 / 6.5	IPD/KT-IN-00	IPD/KT-IN-01
Standard	3.5 / 5.0 / 6.5	IPD/KT-IR-00	IPD/KT-IR-01
Wide	3.5 / 5.0 / 6.5	IPD/KT-IW-00	IPD/KT-IW-01

All kits include the locking screw IPD/KA-TI-00

SCAN BODY SCREWDRIVER

	Scan Body height (mm)	Reference
	10	IPD/PH-20-18
	15	IPD/PH-20-25



Compatibility	Platform	Connection	Gingival height (mm)	Reference	Cutting guides
Nobel Biocare® Branemark System® Klockner® KL™	Ø3.5	Engaging	1.5	IPD/AA-IN-02/3D	IPD/KT-IN-00
		Non-engaging		IPD/AA-IN-03/3D	IPD/KT-IN-01
Nobel Biocare® Branemark System® Biomet® 3i® Osseotite® BTI® Hex. Ext. Sweden & Martina® Outlink® Microdent® Microdent® Universal™ Klockner® KL™	Ø4.1	Engaging	0.5	IPD/AA-IR-00/3D	IPD/KT-IR-00
			1.5	IPD/AA-IR-02/3D	
		Non-engaging	2.5	IPD/AA-IR-04/3D	IPD/KT-IR-01
			0.5	IPD/AA-IR-01/3D	
Phibo® TSH®	S3-S4	Non-engaging	1.5	IPD/AA-IR-03/3D	IPD/KT-IR-01
Nobel Biocare® Branemark System®	Ø5.1	Engaging	1.3	IPD/AA-IW-02/3D	IPD/KT-IW-00
		Non-engaging		IPD/AA-IW-03/3D	-
Nobel Biocare® Multii-unit System	Ø4.8	Engaging	0.5	IPD/AB-IR-00/3D	-
			0.5	IPD/AB-IR-02/3D	-
		Non-engaging	0.2	IPD/AB-IR-01/3D	-
			0.2	IPD/AB-IR-03/3D	-
Nobel Biocare® Replace® Select	Ø3.5	Engaging	0.5	IPD/AC-IN-00/3D	IPD/KT-IN-00
			1.5	IPD/AC-IN-02/3D	
			2.5	IPD/AC-IN-04/3D	
	Non-engaging	0.5	IPD/AC-IN-01/3D	IPD/KT-IN-01	
		1.5	IPD/AC-IN-03/3D		
		2.5	IPD/AC-IN-05/3D		
Ø4.3	Engaging	0.5	IPD/AC-IR-00/3D	IPD/KT-IR-00	
		1.5	IPD/AC-IR-02/3D		
	Non-engaging	0.5	IPD/AC-IR-01/3D	IPD/KT-IR-01	
		1.5	IPD/AC-IR-03/3D		
Ø5.0	Engaging	0.5	IPD/AC-IW-00/3D	IPD/KT-IW-00	
		1.5	IPD/AC-IW-02/3D		
		1.5	IPD/AC-IW-01/3D	IPD/KT-IW-01	
Non-engaging	0.5	IPD/AC-IW-03/3D			
	1.5	IPD/AC-IW-01/3D	IPD/KT-IW-01		
	1.5	IPD/AC-IW-03/3D			

Compatibility	Platform	Connection	Gingival height (mm)	Reference	Cutting guides
Nobel Biocare® Nobel Active®	Ø3.0	Engaging	0.8	IPD/AD-IT-00/3D	IPD/KT-IN-00
			1.5	IPD/AD-IT-02/3D	
			2.5	IPD/AD-IT-04/3D	
		Non-engaging	0.8	IPD/AD-IT-01/3D	IPD/KT-IN-01
			1.5	IPD/AD-IT-03/3D	
	Ø3.5	Engaging	2.5	IPD/AD-IT-05/3D	IPD/KT-IN-00
			0.5	IPD/AD-IN-00/3D	
			1.5	IPD/AD-IN-02/3D	
		Non-engaging	2.5	IPD/AD-IN-04/3D	IPD/KT-IN-01
			3.5	IPD/AD-IN-06/3D	
Biomet® 3i® Osseotite®	Ø4.3	Engaging	0.5	IPD/AD-IN-01/3D	IPD/KT-IN-01
			1.5	IPD/AD-IN-03/3D	
			2.5	IPD/AD-IN-05/3D	
		Non-engaging	3.5	IPD/AD-IN-07/3D	IPD/KT-IR-00
			0.5	IPD/AD-IR-00/3D	
	Ø3.4	Engaging	1.5	IPD/AD-IR-02/3D	IPD/KT-IR-01
			2.5	IPD/AD-IR-04/3D	
			0.5	IPD/AD-IR-01/3D	
		Non-engaging	1.5	IPD/AD-IR-03/3D	IPD/KT-IR-00
			2.5	IPD/AD-IR-05/3D	
Microdent® Microdent® Universal™	Ø5.0	Engaging	0.5	IPD/BA-IN-02/3D	IPD/KT-IN-00
			1.5	IPD/BA-IN-03/3D	IPD/KT-IN-01
	Non-engaging	0.5	IPD/BA-IW-00/3D	IPD/KT-IW-00	
		1.5	IPD/BA-IW-02/3D	IPD/KT-IW-01	
Biomet® 3i® Certain®	Ø5.1	Engaging	0.5	IPD/BA-IW-01/3D	IPD/KT-IW-01
			1.5	IPD/BA-IW-03/3D	
			0.5	IPD/BB-IN-00/3D	
		Non-engaging	1.5	IPD/BB-IN-02/3D	IPD/KT-IN-00
			2.5	IPD/BB-IN-04/3D	
	Ø3.4	Engaging	0.5	IPD/BB-IN-01/3D	IPD/KT-IN-01
			1.5	IPD/BB-IN-03/3D	
			2.5	IPD/BB-IN-05/3D	
		Non-engaging	0.5	IPD/BB-IR-00/3D	IPD/KT-IR-00
			1.5	IPD/BB-IR-02/3D	
Ø4.1	Engaging	0.5	IPD/BB-IR-01/3D	IPD/KT-IR-01	
		1.5	IPD/BB-IR-03/3D		
		0.5	IPD/BB-IW-00/3D		
	Non-engaging	1.5	IPD/BB-IW-02/3D	IPD/KT-IW-00	
		0.5	IPD/BB-IW-01/3D	IPD/KT-IW-01	
Ø5.0	Engaging	1.5	IPD/BB-IW-03/3D		
		0.5	IPD/BB-IW-01/3D	IPD/KT-IW-01	
		1.5	IPD/BB-IW-03/3D		

Compatibility	Platform	Connection	Gingival height (mm)	Reference	Cutting guides
Klockner® SK2-NK2	Ø4.2	Engaging	2.25	IPD/CA-IR-04/3D	IPD/KT-IR-00
		Non-engaging		IPD/CA-IR-05/3D	IPD/KT-IR-01
Klockner® Essential Cone®	Ø4.5	Engaging	0.5	IPD/CB-IR-00/3D	IPD/KT-IR-00
		Non-engaging		IPD/CB-IR-01/3D	IPD/KT-IR-01
	Ø3.5	Engaging	0.7	IPD/CD-IN-00/3D	IPD/KT-IN-00
			1.5	IPD/CD-IN-02/3D	
Ø3.5	Non-engaging	2.5	IPD/CD-IN-04/3D	IPD/KT-IN-01	
		0.7	IPD/CD-IN-01/3D		
Klockner® Vega®	Ø4.1/Ø4.5	Engaging	1.5	IPD/CD-IN-03/3D	IPD/KT-IR-00
			2.5	IPD/CD-IN-05/3D	
			0.7	IPD/CD-IR-00/3D	
	Ø4.1/Ø4.5	Non-engaging	1.5	IPD/CD-IR-02/3D	IPD/KT-IR-00
			2.5	IPD/CD-IR-04/3D	
			0.7	IPD/CD-IR-01/3D	
Straumann® Tissue Level	Ø4.8	Engaging	0.4	IPD/DA-IR-00/3D	IPD/KT-IR-00
		Non-engaging		IPD/DA-IR-01/3D	IPD/KT-IR-01
	Ø6.5	Engaging	1.25	IPD/DA-IW-02/3D	IPD/KT-IW-00
		Non-engaging		IPD/DA-IW-03/3D	IPD/KT-IW-01
	Ø3.3 NC	Engaging	0.5	IPD/DB-IN-00/3D	IPD/KT-IN-00
			1.5	IPD/DB-IN-02/3D	
2.5			IPD/DB-IN-04/3D		
Ø3.3 NC		Non-engaging	3.5	IPD/DB-IN-06/3D	IPD/KT-IN-01
			0.5	IPD/DB-IN-01/3D	
			1.5	IPD/DB-IN-03/3D	
Straumann® Bone Level	Ø3.3 NC	Non-engaging	2.5	IPD/DB-IN-05/3D	IPD/KT-IN-01
			3.5	IPD/DB-IN-07/3D	
			0.5	IPD/DB-IR-00/3D	
	Ø4.1 RC	Engaging	1.5	IPD/DB-IR-02/3D	IPD/KT-IR-00
			2.5	IPD/DB-IR-04/3D	
			3.5	IPD/DB-IR-06/3D	
Straumann® BLX®	Ø4.1 RC	Non-engaging	0.5	IPD/DB-IR-01/3D	IPD/KT-IR-01
			1.5	IPD/DB-IR-03/3D	
			2.5	IPD/DB-IR-05/3D	
	RB/WB	Engaging	3.5	IPD/DB-IR-07/3D	IPD/KT-IR-01
			1	IPD/DC-IR-00/3D	
			2	IPD/DC-IR-02/3D	
Ø4.1 RC	Non-engaging	3	IPD/DC-IR-04/3D	IPD/KT-IR-00	
		1	IPD/DC-IR-01/3D		
		2	IPD/DC-IR-03/3D		
		3	IPD/DC-IR-05/3D		

Compatibility	Platform	Connection	Gingival height (mm)	Reference	Cutting guides	
Astra® Osseospeed®	Ø3.0	Engaging	0.8	IPD/EA-IN-00/3D	IPD/KT-IN-00	
			1.5	IPD/EA-IN-02/3D		
			2.5	IPD/EA-IN-04/3D		
		Ø3.0	Non-engaging	0.8	IPD/EA-IN-01/3D	IPD/KT-IN-01
				1.5	IPD/EA-IN-03/3D	
				2.5	IPD/EA-IN-05/3D	
	Ø3.5-4.0	Engaging	0.5	IPD/EA-IR-00/3D	IPD/KT-IN-00	
			1.5	IPD/EA-IR-02/3D		
			2.5	IPD/EA-IR-04/3D		
		Ø3.5-4.0	Non-engaging	3.5	IPD/EA-IR-06/3D	IPD/KT-IN-01
				0.5	IPD/EA-IR-01/3D	
				1.5	IPD/EA-IR-03/3D	
Ø4.5-5.0	Engaging	2.5	IPD/EA-IR-05/3D	IPD/KT-IN-01		
		3.5	IPD/EA-IR-07/3D			
		0.5	IPD/EA-IW-00/3D			
	Ø4.5-5.0	Non-engaging	1.5	IPD/EA-IW-02/3D	IPD/KT-IR-00	
			0.5	IPD/EA-IW-01/3D		
			1.5	IPD/EA-IW-03/3D		
Astra® Evolution®	Ø3.6	Engaging	0.5	IPD/EB-IN-00/3D	IPD/KT-IN-00	
			1.5	IPD/EB-IN-02/3D		
			2.5	IPD/EB-IN-04/3D		
	Ø3.6	Non-engaging	0.5	IPD/EB-IN-01/3D	IPD/KT-IN-01	
			1.5	IPD/EB-IN-03/3D		
			2.5	IPD/EB-IN-05/3D		
Ø4.2	Engaging	0.5	IPD/EB-IR-00/3D	IPD/KT-IR-00		
		1.5	IPD/EB-IR-02/3D			
		2.5	IPD/EB-IR-04/3D			
	Ø4.2	Non-engaging	0.5	IPD/EB-IR-01/3D	IPD/KT-IR-01	
			1.5	IPD/EB-IR-03/3D		
			2.5	IPD/EB-IR-05/3D		
Zimmer® Screw Vent®	Ø3.5	Engaging	0.5	IPD/FA-IN-00/3D	IPD/KT-IN-00	
			1.5	IPD/FA-IN-02/3D		
			2.5	IPD/FA-IN-04/3D		
	Ø3.5	Non-engaging	0.5	IPD/FA-IN-01/3D	IPD/KT-IN-01	
			1.5	IPD/FA-IN-03/3D		
			2.5	IPD/FA-IN-05/3D		
Ø4.5	Engaging	0.5	IPD/FA-IR-00/3D	IPD/KT-IR-00		
		1.5	IPD/FA-IR-02/3D			
		2.5	IPD/FA-IR-04/3D			
	Ø4.5	Non-engaging	0.5	IPD/FA-IR-01/3D	IPD/KT-IR-01	
			1.5	IPD/FA-IR-03/3D		
			2.5	IPD/FA-IR-05/3D		
Ø5.7	Engaging	0.5	IPD/FA-IW-00/3D	IPD/KT-IW-00		
	Non-engaging	0.5	IPD/FA-IW-01/3D	IPD/KT-IW-01		

Compatibility	Platform	Connection	Gingival height (mm)	Reference	Cutting guides		
Zimmer® Eztetic®	Ø31	Engaging	1	IPD/FC-IT-00/3D	IPD/KT-IN-00		
			2	IPD/FC-IT-02/3D			
			3	IPD/FC-IT-04/3D			
		Non-engaging	1	IPD/FC-IT-01/3D			
			2	IPD/FC-IT-03/3D			
BTI® Tiny BTI®	Ø3.5	Engaging	1.5	IPD/GA-IN-02/3D	IPD/KT-IN-00		
			Non-engaging	1.5	IPD/GA-IN-03/3D	IPD/KT-IN-01	
		BTI® Interna Universal®	Ø4.1	Engaging	0.5	IPD/GB-IR-00/3D	IPD/KT-IR-00
1.5	IPD/GB-IR-02/3D						
2.5	IPD/GB-IR-04/3D						
BTI® Multi-im®	Ø4.1	Non-engaging	0.5	IPD/GB-IR-01/3D	IPD/KT-IR-01		
			1.5	IPD/GB-IR-03/3D			
			2.5	IPD/GB-IR-05/3D			
BTI® Multi-im®	Ø3.4	Non-engaging	0.3	IPD/GC-IR-01/3D	-		
			Engaging	1.5	IPD/IA-IN-02/3D	IPD/KT-IN-00	
			Non-engaging	1.5	IPD/IA-IN-03/3D	IPD/KT-IN-01	
Dentsply® Xive® Friadent®	Ø3.8	Engaging	0.5	IPD/IA-IR-00/3D	IPD/KT-IR-00		
			1.5	IPD/IA-IR-02/3D			
			Non-engaging	0.5		IPD/IA-IR-01/3D	IPD/KT-IR-01
1.5	IPD/IA-IR-03/3D						
Dentsply® Ankylos®	C/X	Engaging	1.5	IPD/IB-IR-02/3D	IPD/KT-IR-00		
			2.5	IPD/IB-IR-04/3D			
			Non-engaging	1.5		IPD/IB-IR-03/3D	IPD/KT-IR-01
2.5	IPD/IB-IR-05/3D						
Camlog® Camlog®	Ø3.3	Engaging	1.5	IPD/JA-IN-02/3D	IPD/KT-IN-00		
			Non-engaging	1.5		IPD/JA-IN-03/3D	IPD/KT-IN-01
			Engaging	0.5		IPD/JA-IR-00/3D	
Camlog® Camlog®	Ø3.8	Non-engaging	1.5	IPD/JA-IR-02/3D	IPD/KT-IR-00		
			0.5	IPD/JA-IR-01/3D		IPD/KT-IR-01	
			1.5	IPD/JA-IR-03/3D			
Camlog® Camlog®	Ø4.3	Engaging	0.5	IPD/JA-IW-00/3D	IPD/KT-IR-00		
			1.5	IPD/JA-IW-02/3D			
			Non-engaging	0.5		IPD/JA-IW-01/3D	IPD/KT-IR-01
1.5	IPD/JA-IW-03/3D						
Camlog® Camlog®	Ø3.0	Engaging	0.5	IPD/LB-IT-00/3D	IPD/KT-IN-00		
			1.5	IPD/LB-IT-02/3D			
			Non-engaging	2.5		IPD/LB-IT-04/3D	IPD/KT-IN-01
0.5	IPD/LB-IT-01/3D						
Camlog® Camlog®	Ø3.5	Non-engaging	2.5	IPD/LB-IT-05/3D	IPD/KT-IN-01		
			0.5	IPD/LB-IN-00/3D		IPD/KT-IN-00	
			1.5	IPD/LB-IN-02/3D			
BioHorizons® Tapered Internal	Ø3.5	Engaging	2.5	IPD/LB-IN-04/3D	IPD/KT-IN-00		
			0.5	IPD/LB-IN-01/3D		IPD/KT-IN-01	
			1.5	IPD/LB-IN-03/3D			
BioHorizons® Tapered Internal	Ø4.5	Non-engaging	2.5	IPD/LB-IN-05/3D	IPD/KT-IN-01		
			0.5	IPD/LB-IR-00/3D		IPD/KT-IR-00	
			1.5	IPD/LB-IR-02/3D			
BioHorizons® Tapered Internal	Ø4.5	Engaging	2.5	IPD/LB-IR-04/3D	IPD/KT-IR-00		
			0.5	IPD/LB-IR-01/3D		IPD/KT-IR-01	
			1.5	IPD/LB-IR-03/3D			
BioHorizons® Tapered Internal	Ø5.7	Non-engaging	2.5	IPD/LB-IR-05/3D	IPD/KT-IR-01		
			0.5	IPD/LB-IW-00/3D		IPD/KT-IW-00	
			0.5	IPD/LB-IW-01/3D			

Compatibility	Platform	Connection	Gingival height (mm)	Reference	Cutting guides		
Sweden & Martina® Outlink®	Ø3.5	Engaging	1.5	IPD/MA-IN-02/3D	IPD/KT-IN-00		
			2.5	IPD/MA-IN-04/3D			
			Non-engaging	1.5		IPD/MA-IN-03/3D	IPD/KT-IN-01
			2.5	IPD/MA-IN-05/3D			
			Sweden & Martina® Outlink®	Ø5.0		Engaging	0.5
1.5	IPD/BA-IW-02/3D						
Non-engaging	0.5	IPD/BA-IW-01/3D			IPD/KT-IW-01		
1.5	IPD/BA-IW-03/3D						
Sweden & Martina® Premium™ Kohno®	Ø3.3	Engaging	0.5	IPD/MB-IT-00/3D	IPD/KT-IN-00		
			1.5	IPD/MB-IT-02/3D			
			Non-engaging	0.5		IPD/MB-IT-01/3D	IPD/KT-IN-01
1.5	IPD/MB-IT-03/3D						
Sweden & Martina® Premium™ Kohno®	Ø3.8	Engaging	0.7	IPD/MB-IN-00/3D	IPD/KT-IN-00		
			1.5	IPD/MB-IN-02/3D			
			Non-engaging	0.7		IPD/MB-IN-01/3D	IPD/KT-IN-01
1.5	IPD/MB-IN-03/3D						
Sweden & Martina® Premium™ Kohno®	Ø4.25	Engaging	0.7	IPD/MB-IR-00/3D	IPD/KT-IR-00		
			1.5	IPD/MB-IR-02/3D			
			Non-engaging	0.7		IPD/MB-IR-01/3D	IPD/KT-IR-01
1.5	IPD/MB-IR-03/3D						
Phibo® TSH®	S2	Engaging	1.5	IPD/NA-IN-02/3D	IPD/KT-IN-00		
			Non-engaging	1.5		IPD/NA-IN-03/3D	IPD/KT-IN-01
			Engaging	1.3		IPD/NA-IW-02/3D	
Non-engaging	1.3	IPD/NA-IW-03/3D					
Phibo® TSH®	Ø3.5 Mini	Engaging	1	IPD/OB-IN-00/3D	IPD/KT-IN-00		
			2	IPD/OB-IN-02/3D			
			Non-engaging	3		IPD/OB-IN-04/3D	IPD/KT-IN-01
1	IPD/OB-IN-01/3D						
Osstem® TSIII®	Ø4.0 Regular	Non-engaging	2	IPD/OB-IN-03/3D	IPD/KT-IN-01		
			3	IPD/OB-IN-05/3D			
			Engaging	1		IPD/OB-IR-00/3D	IPD/KT-IR-00
2	IPD/OB-IR-02/3D						
Osstem® TSIII®	Ø4.0 Regular	Non-engaging	3	IPD/OB-IR-04/3D	IPD/KT-IR-01		
			1	IPD/OB-IR-01/3D			
			2	IPD/OB-IR-03/3D			
Osstem® TSIII®	Ø4.0 Regular	Engaging	3	IPD/OB-IR-05/3D	IPD/KT-IR-01		
			1	IPD/QB-IR-00/3D			
			2	IPD/QB-IR-02/3D		IPD/KT-IR-00	
3	IPD/QB-IR-04/3D						
Biotech® Dental Kontakt®	RP	Non-engaging	1	IPD/QB-IR-01/3D	IPD/KT-IR-01		
			2	IPD/QB-IR-03/3D			
			3	IPD/QB-IR-05/3D			

Compatibility	Platform	Connection	Gingival height (mm)	Reference	Cutting guides	
Neodent® Grand Morse™ GM	GM	Engaging	1	IPD/RB-IR-00/3D	IPD/KT-IR-00	
			2	IPD/RB-IR-02/3D		
			3	IPD/RB-IR-04/3D		
		Non-engaging	1	IPD/RB-IR-01/3D		IPD/KT-IR-01
			2	IPD/RB-IR-03/3D		
			3	IPD/RB-IR-05/3D		
	Ø3.25/3.75	Engaging	0.5	IPD/SB-IN-00/3D	IPD/KT-IN-00	
			1.5	IPD/SB-IN-02/3D		
		Non-engaging	2.5	IPD/SB-IN-04/3D		
			0.5	IPD/SB-IN-01/3D		IPD/KT-IN-01
1.5	IPD/SB-IN-03/3D					
2.5	IPD/SB-IN-05/3D					
Bego® Semados®	Ø4.1	Engaging	0.7	IPD/SB-IR-00/3D	IPD/KT-IR-00	
			1.7	IPD/SB-IR-02/3D		
			2.7	IPD/SB-IR-04/3D		
		Non-engaging	0.7	IPD/SB-IR-01/3D		IPD/KT-IR-01
			1.7	IPD/SB-IR-03/3D		
			2.7	IPD/SB-IR-05/3D		
	Ø4.5	Engaging	0.5	IPD/SB-IW-00/3D	IPD/KT-IR-00	
			1.5	IPD/SB-IW-02/3D		
		Non-engaging	2.5	IPD/SB-IW-04/3D		
			0.5	IPD/SB-IW-01/3D		IPD/KT-IR-01
1.5	IPD/SB-IW-03/3D					
2.5	IPD/SB-IW-05/3D					
MIS® Seven®	Narrow Ø3.3	Engaging	0.5	IPD/TA-IT-00/3D	IPD/KT-IN-00	
			1.5	IPD/TA-IT-02/3D		
			2.5	IPD/TA-IT-04/3D		
		Non-engaging	0.5	IPD/TA-IT-01/3D		IPD/KT-IN-01
			1.5	IPD/TA-IT-03/3D		
			2.5	IPD/TA-IT-05/3D		
	Standard	Engaging	0.5	IPD/FA-IN-00/3D	IPD/KT-IN-00	
			1.5	IPD/FA-IN-02/3D		
		Non-engaging	2.5	IPD/FA-IN-04/3D		
			0.5	IPD/FA-IN-01/3D		IPD/KT-IN-01
1.5	IPD/FA-IN-03/3D					
2.5	IPD/FA-IN-05/3D					
Wide	Engaging	0.5	IPD/FA-IR-00/3D	IPD/KT-IR-00		
		1.5	IPD/FA-IR-02/3D			
		2.5	IPD/FA-IR-04/3D			
	Non-engaging	0.5	IPD/FA-IR-01/3D		IPD/KT-IR-01	
		1.5	IPD/FA-IR-03/3D			
		2.5	IPD/FA-IR-05/3D			

Compatibility	Platform	Connection	Gingival height (mm)	Reference	Cutting guides	
MIS® C1/V3®	Standard	Engaging	0.7	IPD/TB-IR-00/3D	IPD/KT-IR-00	
			1.5	IPD/TB-IR-02/3D		
			2.5	IPD/TB-IR-04/3D		
		Non-engaging	3.5	IPD/TB-IR-06/3D		IPD/KT-IR-01
			0.5	IPD/TB-IR-01/3D		
			1.5	IPD/TB-IR-03/3D		
	NP	Engaging	2.5	IPD/TB-IR-05/3D	IPD/KT-IR-01	
			3.5	IPD/TB-IR-07/3D		
		Non-engaging	1	IPD/UB-IN-00/3D		
			2	IPD/UB-IN-02/3D		IPD/KT-IN-00
3	IPD/UB-IN-04/3D					
DIO® UFII	RP	Non-engaging	1	IPD/UB-IN-01/3D	IPD/KT-IN-01	
			2	IPD/UB-IN-03/3D		
			3	IPD/UB-IN-05/3D		
		Engaging	1	IPD/UB-IR-00/3D		IPD/KT-IR-00
			2	IPD/UB-IR-02/3D		
			3	IPD/UB-IR-04/3D		
	RP	Non-engaging	1	IPD/UB-IR-01/3D	IPD/KT-IR-01	
			2	IPD/UB-IR-03/3D		
		Engaging	3	IPD/UB-IR-05/3D		
			1	IPD/WA-IR-00/3D		IPD/KT-IR-00
2	IPD/WA-IR-02/3D					
3	IPD/WA-IR-04/3D					
Megagen® AnyOne®	RP	Non-engaging	1	IPD/WA-IR-01/3D	IPD/KT-IR-01	
			2	IPD/WA-IR-03/3D		
			3	IPD/WA-IR-05/3D		
		Engaging	1	IPD/WB-IR-00/3D		IPD/KT-IR-00
			2	IPD/WB-IR-02/3D		
			3	IPD/WB-IR-04/3D		
	RP	Non-engaging	1	IPD/WB-IR-01/3D	IPD/KT-IR-01	
			2	IPD/WB-IR-03/3D		
		Engaging	3	IPD/WB-IR-05/3D		
			1	IPD/XA-IR-00/3D		IPD/KT-IR-00
2	IPD/XA-IR-02/3D					
3	IPD/XA-IR-04/3D					
Dentium® Implantium® / Superline™	RP	Non-engaging	1	IPD/XA-IR-01/3D	IPD/KT-IR-01	
			2	IPD/XA-IR-03/3D		
			3	IPD/XA-IR-05/3D		
		Engaging	1	IPD/YB-IR-00/3D		IPD/KT-IR-00
			2	IPD/YB-IR-02/3D		
			3	IPD/YB-IR-04/3D		
	RP	Non-engaging	1	IPD/YB-IR-01/3D	IPD/KT-IR-01	
			2	IPD/YB-IR-03/3D		
		Engaging	3	IPD/YB-IR-05/3D		
			1	IPD/YB-IR-00/3D		IPD/KT-IR-00
2	IPD/YB-IR-02/3D					
3	IPD/YB-IR-04/3D					
Medentis® ICX	RP	Non-engaging	1	IPD/YB-IR-01/3D	IPD/KT-IR-01	
			2	IPD/YB-IR-03/3D		
		3	IPD/YB-IR-05/3D			

WORKFLOW DIAGRAM

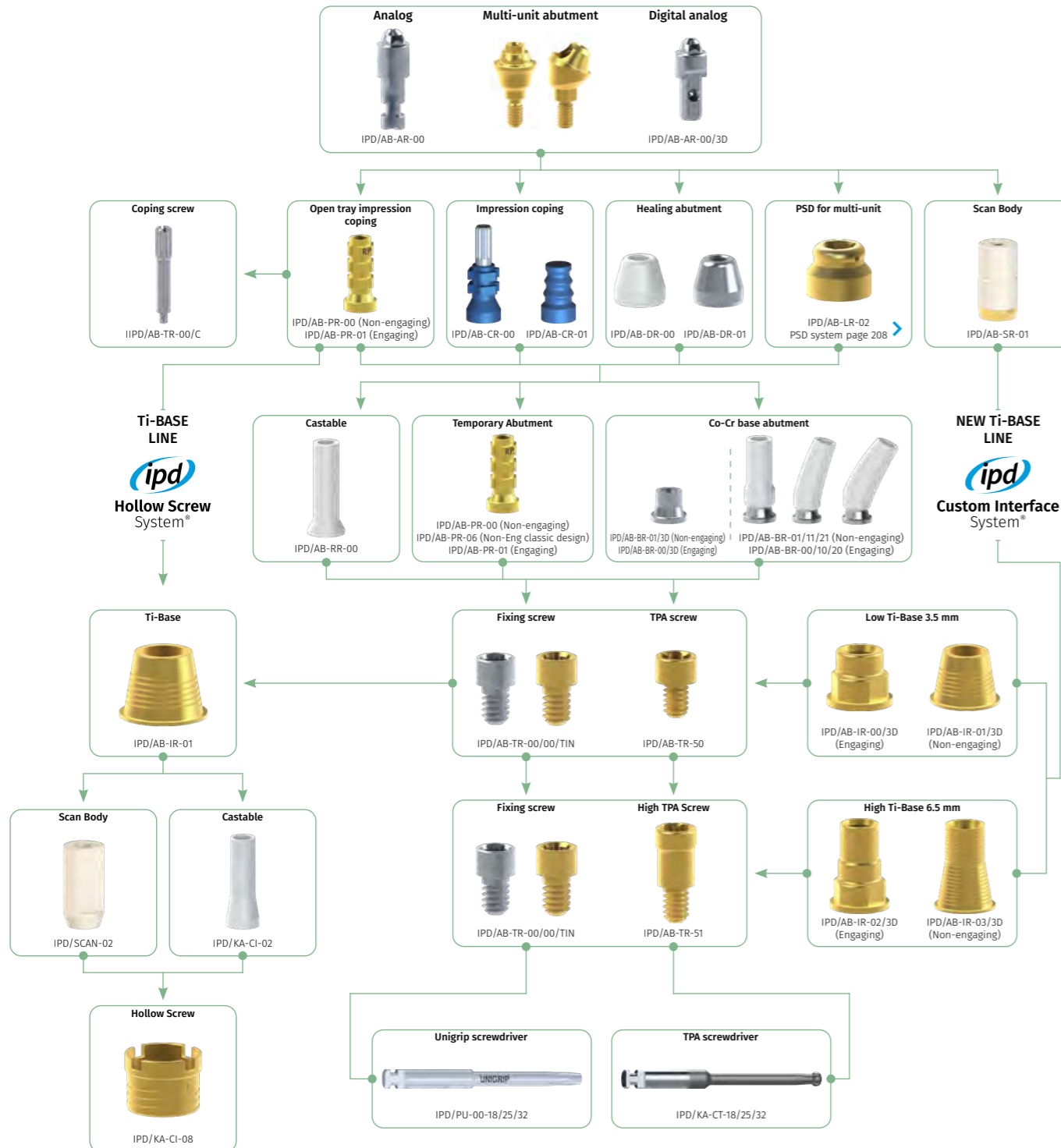

ANALOG / DIGITAL ANALOG

Platform	Reference	Digital reference
ø4.8	IPD/AB-AR-00	IPD/AB-AR-00/3D
Lower Screw	-	IPD/KA-TA-00
Transverse Screw	-	IPD/KA-TA-01



SCAN BODY

Platform	Height (mm)		
ø4.8	10.0	IPD/AB-SR-00	IPD/AB-SR-01

Captive screw included. 1.20 Hex Screwdriver.



TEMPORARY ABUTMENT/ OPEN TRAY COPING

Platform			Coping screw
ø4.8	IPD/AB-PR-01	IPD/AB-PR-00	IPD/AB-TR-00/C
	-	IPD/AB-PR-06	-

The same abutment can be used as a temporary abutment with the occlusal screw or as an impression coping using the coping screw.
IPD/AB-PR-06 corresponds to the classic design and cannot be used as a coping.



Ti-BASE

Platform	Height (mm)		
ø4.8	3.5	IPD/AB-IR-00/3D	IPD/AB-IR-01/3D
	6.5	-	IPD/AB-IR-01
		IPD/AB-IR-02/3D	IPD/AB-IR-03/3D



STRAIGHT AND ANGLED CASTABLE ABUTMENT WITH A Co-Cr BASE
Straight, 15° & 25°

Platform	Angulation		
ø4.8	Straight	IPD/AB-BR-00	IPD/AB-BR-01
	15°	IPD/AB-BR-10	IPD/AB-BR-11
	25°	IPD/AB-BR-20	IPD/AB-BR-21

All angled castable abutments include a TPA screw.



OPEN AND CLOSED TRAY COPING

Platform	Reference
ø4.8	Open tray coping
	Closed tray coping
	IPD/AB-CR-00
	IPD/AB-CR-01

Classic design.



HEALING ABUTMENT

Titanium / Plastic POM

Platform	Material	Reference
ø4.8	Plastic POM	IPD/AB-DR-00
	Titanium	IPD/AB-DR-01

IPD/AB-TR-00 screw not include.



CASTABLE

Platform	Reference
ø4.8	IPD/AB-RR-00



Co-Cr 3D BASE / SCAN BODY

Platform		Scan Body
ø4.8	Straight / Angled	IPD/SC-AN-B2



PSD FOR MULTI-UNIT

Platform	Units	Height	Reference
ø4.8	2	3.35 mm	IPD/AB-LR-02



SCREW

Platform	Screwdriver	Reference	TiN ReferenCE
ø4.8	Unigrip	IPD/AB-TR-00	IPD/AB-TR-00/TIN



TPA SCREW FOR ANGLED PROSTHESIS

Platform	Height	Reference
ø4.8	For 3.5 mm high Ti-Base	IPD/AB-TR-50
	For 6.5 mm high Ti-Base	IPD/AB-TR-51



ANGLED MULTI-UNIT CARRIER

Platform	Reference
ø4.8	IPD/LL-TM-00



UNIGRIP SCREWDRIVER

Lengths (mm)	Reference
18	IPD/PU-00-18
25	IPD/PU-00-25
32	IPD/PU-00-32



STRAIGHT MULTI-UNIT SCREWDRIVER

Lengths (mm)	Reference
20	IPD/LL-AB-00



Compatibility	Platform	Angulation	Height (mm)	Reference	
Nobel Biocare® Branemark System® Biomet® 3i® Osseotite® BTI® Hex. Ext. Sweden & Martina® Outlink® Microdent® Microdent® Universal™ Klockner® KL™	ø4.1	Straight	1	IPD/AB-MR-01	
			2	IPD/AB-MR-02	
			3	IPD/AB-MR-03	
			4	IPD/AB-MR-04	
			5	IPD/AB-MR-05	
	Phibo® TSH®	S3-S4	30°	2	IPD/AB-MR-12
				3	IPD/AB-MR-13
				4	IPD/AB-MR-14
				3	IPD/AB-MR-33
				4	IPD/AB-MR-34
Nobel Biocare® Nobel Replace® Select	ø3.5	Straight	1	IPD/AC-MN-01	
			2	IPD/AC-MN-02	
			1	IPD/AC-MR-01	
			2	IPD/AC-MR-02	
			3	IPD/AC-MR-03	
	ø4.3	Straight	4	IPD/AC-MR-04	
			5	IPD/AC-MR-05	
			2	IPD/AC-MR-12	
			3	IPD/AC-MR-13	
			4	IPD/AC-MR-34	
Nobel Biocare® Nobel Active®	ø3.5	Straight	1.5	IPD/AD-MN-01	
			2.5	IPD/AD-MN-02	
			3.5	IPD/AD-MN-03	
			4.5	IPD/AD-MN-04	
			2.5	IPD/AD-MN-12	
	ø4.3	Straight	3.5	IPD/AD-MN-13	
			3.5	IPD/AD-MN-33	
			4.5	IPD/AD-MN-34	
			1.5	IPD/AD-MR-01	
			2.5	IPD/AD-MR-02	
ø4.3	Straight	3.5	IPD/AD-MR-03		
		4.5	IPD/AD-MR-04		
		2.5	IPD/AD-MR-12		
		3.5	IPD/AD-MR-13		
		3.5	IPD/AD-MR-33		
Biomet® 3i® Certain®	ø4.1	Straight	4.5	IPD/AD-MR-34	
			1	IPD/BB-MR-01	
			2	IPD/BB-MR-02	
			3	IPD/BB-MR-03	
			4	IPD/BB-MR-04	
			5	IPD/BB-MR-05	

Compatibility	Platform	Angulation	Height (mm)	Reference		
Biomet® 3i® Certain®	ø4.5	17°	2	IPD/BB-MR-12		
			3	IPD/BB-MR-13		
			4	IPD/BB-MR-34		
			1.5	IPD/CD-MN-01		
			2.5	IPD/CD-MN-02		
	Klockner® Vega®	ø3.5	Straight	3.5	IPD/CD-MN-03	
				4.5	IPD/CD-MN-04	
				5.5	IPD/CD-MN-05	
				17°	2.5	IPD/CD-MN-12
				30°	3.5	IPD/CD-MN-33
Straumann® Tissue Level	ø4.0 / ø4.5	Straight	1.5	IPD/CD-MR-01		
			2.5	IPD/CD-MR-02		
			3.5	IPD/CD-MR-03		
			4.5	IPD/CD-MR-04		
			5.5	IPD/CD-MR-05		
	ø4.8	Straight	17°	2.5	IPD/CD-MR-12	
			30°	3.5	IPD/CD-MR-33	
			0.9	IPD/DA-MR-01		
			1.5	IPD/DB-MN-01		
			2.5	IPD/DB-MN-02		
Straumann® Bone Level	ø3.3 NC	Straight	3.5	IPD/DB-MN-03		
			4.5	IPD/DB-MN-04		
			17°	2.5	IPD/DB-MN-12	
			3.5	IPD/DB-MN-13		
			3.5	IPD/DB-MN-33		
	ø4.1 RC	Straight	30°	4.5	IPD/DB-MN-34	
			1.5	IPD/DB-MR-01		
			2.5	IPD/DB-MR-02		
			3.5	IPD/DB-MR-03		
			4.5	IPD/DB-MR-04		
ø4.3	Straight	17°	2.5	IPD/DB-MR-12		
		3.5	IPD/DB-MR-13			
		3.5	IPD/DB-MR-33			
		4.5	IPD/DB-MR-34			
		1.5	IPD/DC-MR-01			
Straumann® BLX®	RB/WB	Straight	2.5	IPD/DC-MR-02		
			3.5	IPD/DC-MR-03		
			17°	3.5	IPD/DC-MR-13	
			30°	4.5	IPD/DC-MR-34	

Compatibility	Platform	Angulation	Height (mm)	Reference	
Astra® Osseospeed™	ø3.5 / ø4.0	Straight	1.5	IPD/EA-MR-01	
			2.5	IPD/EA-MR-02	
			3.5	IPD/EA-MR-03	
		17°	4.5	IPD/EA-MR-04	
			2.5	IPD/EA-MR-12	
			3.5	IPD/EA-MR-13	
			3.5	IPD/EA-MR-33	
	30°	4.5	IPD/EA-MR-34		
		ø4.5 / ø5.0	Straight	1.5	IPD/EA-MW-01
	2.5			IPD/EA-MW-02	
	3.5			IPD/EA-MW-03	
	17°		4.5	IPD/EA-MW-04	
			2.5	IPD/EA-MW-12	
	30°		3.5	IPD/EA-MW-33	
Astra® Evolution®			ø3.6	Straight	1.5
	2.5	IPD/EB-MN-02			
	3.5	IPD/EB-MN-03			
	17°	2.5		IPD/EB-MN-12	
		30°	3.5	IPD/EB-MN-33	
	ø4.2		Straight	1.5	IPD/EB-MR-01
				2.5	IPD/EB-MR-02
17°		3.5	IPD/EB-MR-03		
		30°	2.5	IPD/EB-MR-12	
30°	3.5		IPD/EB-MR-33		
	Zimmer® Screw Vent®	ø3.5	Straight	0.9	IPD/FA-MN-00
1.5				IPD/FA-MN-01	
2.5				IPD/FA-MN-02	
3.5				IPD/FA-MN-03	
17°			4.5	IPD/FA-MN-04	
			2.5	IPD/FA-MN-12	
			3.5	IPD/FA-MN-13	
30°		3.5	IPD/FA-MN-33		
		4.5	IPD/FA-MN-34		
ø4.5		Straight	1.5	IPD/FA-MR-01	
			2.5	IPD/FA-MR-02	
			3.5	IPD/FA-MR-03	
			4.5	IPD/FA-MR-04	
		17°	3	IPD/FA-MR-13	
	4		IPD/FA-MR-14		
	30°		3.5	IPD/FA-MR-33	
4.5		IPD/FA-MR-34			

Compatibility	Platform	Angulation	Height (mm)	Reference	
Zimmer® Eztetic®	ø4.1	Straight	1.5	IPD/FC-MT-01	
			2.5	IPD/FC-MT-02	
			3.5	IPD/FC-MT-03	
		17°	2.5	IPD/FC-MT-12	
			30°	3.5	IPD/FC-MT-33
		BTI® Internal Universal®		ø4.1	Straight
2	IPD/GB-MR-02				
3	IPD/GB-MR-03				
4	IPD/GB-MR-04				
17°	5		IPD/GB-MR-05		
	3		IPD/GB-MR-13		
	4		IPD/GB-MR-14		
30°	4		IPD/GB-MR-34		
	5		IPD/GB-MR-35		
BioHorizons® Tapered Internal	ø3.5		Straight	0.9	IPD/FA-MN-00
				1.5	IPD/FA-MN-01
				2.5	IPD/FA-MN-02
				3.5	IPD/FA-MN-03
			17°	4.5	IPD/FA-MN-04
		2.5		IPD/LB-MN-12	
		3.5		IPD/LB-MN-13	
	30°	3.5	IPD/LB-MN-33		
		4.5	IPD/LB-MN-34		
	ø4.5	Straight	1.5	IPD/FA-MR-01	
			2.5	IPD/FA-MR-02	
			3.5	IPD/FA-MR-03	
			4.5	IPD/FA-MR-04	
		Straight	1.5	IPD/OB-MN-01	
2.5			IPD/OB-MN-02		
3.5			IPD/OB-MN-03		
ø3.5	Straight	4.5	IPD/OB-MN-04		
		5.5	IPD/OB-MN-05		
		2.5	IPD/OB-MN-12		
		3.5	IPD/OB-MN-13		
	17°	3.5	IPD/OB-MN-33		
		30°	4.5	IPD/OB-MN-34	
	Osstem Implant® TSIII		ø4.5	Straight	1.5
2.5		IPD/OB-MR-02			
3.5		IPD/OB-MR-03			
4.5		IPD/OB-MR-04			
Straight		5.5		IPD/OB-MR-05	
		2.5		IPD/OB-MR-12	
		3.5		IPD/OB-MR-13	
30°		3.5	IPD/OB-MR-33		
		4.5	IPD/OB-MR-34		

Compatibility	Platform	Angulation	Height (mm)	Reference
Biotech® Dental Kontakt®	RP	Straight	1.5	IPD/QB-MR-01
			2.5	IPD/QB-MR-02
			3.5	IPD/QB-MR-03
		17°	3.5	IPD/QB-MR-13
		30°	4.5	IPD/QB-MR-34
Neodent® Grand Morse™ GM	GM	Straight	1.5	IPD/RB-MR-01
			2.5	IPD/RB-MR-02
			3.5	IPD/RB-MR-03
		17°	2.5	IPD/RB-MR-12
		30°	3.5	IPD/RB-MR-33
Bego® Semados®	Ø3.25 / Ø3.75	Straight	1.5	IPD/SB-MN-01
			2.5	IPD/SB-MN-02
			3.5	IPD/SB-MN-03
			4.5	IPD/SB-MN-04
			5.5	IPD/SB-MN-05
		17°	2.5	IPD/SB-MN-12
		3.5	IPD/SB-MN-13	
		3.5	IPD/SB-MN-33	
		4.5	IPD/SB-MN-34	
		Ø4.1	Straight	1.5
	2.5			IPD/SB-MR-02
	3.5			IPD/SB-MR-03
	4.5			IPD/SB-MR-04
	17°			2.5
	Ø4.5	Straight	1.5	IPD/SB-MW-01
2.5			IPD/SB-MW-02	
17°			2.5	IPD/SB-MW-12
3.5			IPD/SB-MW-33	
30°			3.5	IPD/SB-MW-33
MIS® Seven®	Standard Ø3.75 / Ø4.2	Straight	0.9	IPD/FA-MN-00
			1.5	IPD/FA-MN-01
			2.5	IPD/FA-MN-02
			3.5	IPD/FA-MN-03
		4.5	IPD/FA-MN-04	
		17°	2.5	IPD/FA-MN-12
		3.5	IPD/FA-MN-13	
		3.5	IPD/FA-MN-33	
		4.5	IPD/FA-MN-34	

Compatibility	Platform	Angulation	Height (mm)	Reference	
MIS® Seven®	Wide Ø5.0 / Ø6.0	Straight	1.5	IPD/FA-MR-01	
			2.5	IPD/FA-MR-02	
			3.5	IPD/FA-MR-03	
		4.5	IPD/FA-MR-04		
		17°	3	IPD/FA-MR-13	
		4	IPD/FA-MR-14		
		30°	3.5	IPD/FA-MR-33	
MIS® C1/V3®	Standard Ø3.75 / Ø4.20	Straight	4.5	IPD/FA-MR-34	
			1	IPD/TB-MR-01	
			2	IPD/TB-MR-02	
		3	IPD/TB-MR-03		
		4	IPD/TB-MR-04		
		17°	2.5	IPD/TB-MR-12	
		30°	3.5	IPD/TB-MR-33	
DIO® UFII	NP	Straight	1.5	IPD/UB-MN-01	
			2.5	IPD/UB-MN-02	
			3.5	IPD/UB-MN-03	
		17°	2.5	IPD/UB-MN-12	
		3.5	IPD/UB-MN-33		
		RP	Straight	1.5	IPD/UB-MR-01
				2.5	IPD/UB-MR-02
				3.5	IPD/UB-MR-03
				17°	2.5
3.5	IPD/UB-MR-33				
30°	3.5			IPD/UB-MR-33	
Megagen® AnyOne®	RP	Straight	1.5	IPD/WA-MR-01	
			2.5	IPD/WA-MR-02	
			3.5	IPD/WA-MR-03	
		17°	2.5	IPD/WA-MR-12	
		3.5	IPD/WA-MR-33		
		30°	3.5	IPD/WA-MR-33	
Megagen® AnyRidge®	RP	Straight	1.5	IPD/WB-MR-01	
			2.5	IPD/WB-MR-02	
			3.5	IPD/WB-MR-03	
		17°	2.5	IPD/WB-MR-12	
		3.5	IPD/WB-MR-33		
		30°	3.5	IPD/WB-MR-33	
Dentium® Implantium® /Superline®	RP	Straight	1.5	IPD/XA-MR-01	
			2.5	IPD/XA-MR-02	
			3.5	IPD/XA-MR-03	
		17°	2.5	IPD/XA-MR-12	
		3.5	IPD/XA-MR-33		
		30°	3.5	IPD/XA-MR-33	
Medentis® ICX	RP	Straight	1.5	IPD/YB-MR-01	
			2.5	IPD/YB-MR-02	
			3.5	IPD/YB-MR-03	
		17°	2.5	IPD/YB-MR-12	
		3.5	IPD/YB-MR-33		
		30°	3.5	IPD/YB-MR-33	

WOKRFLOW DIAGRAM

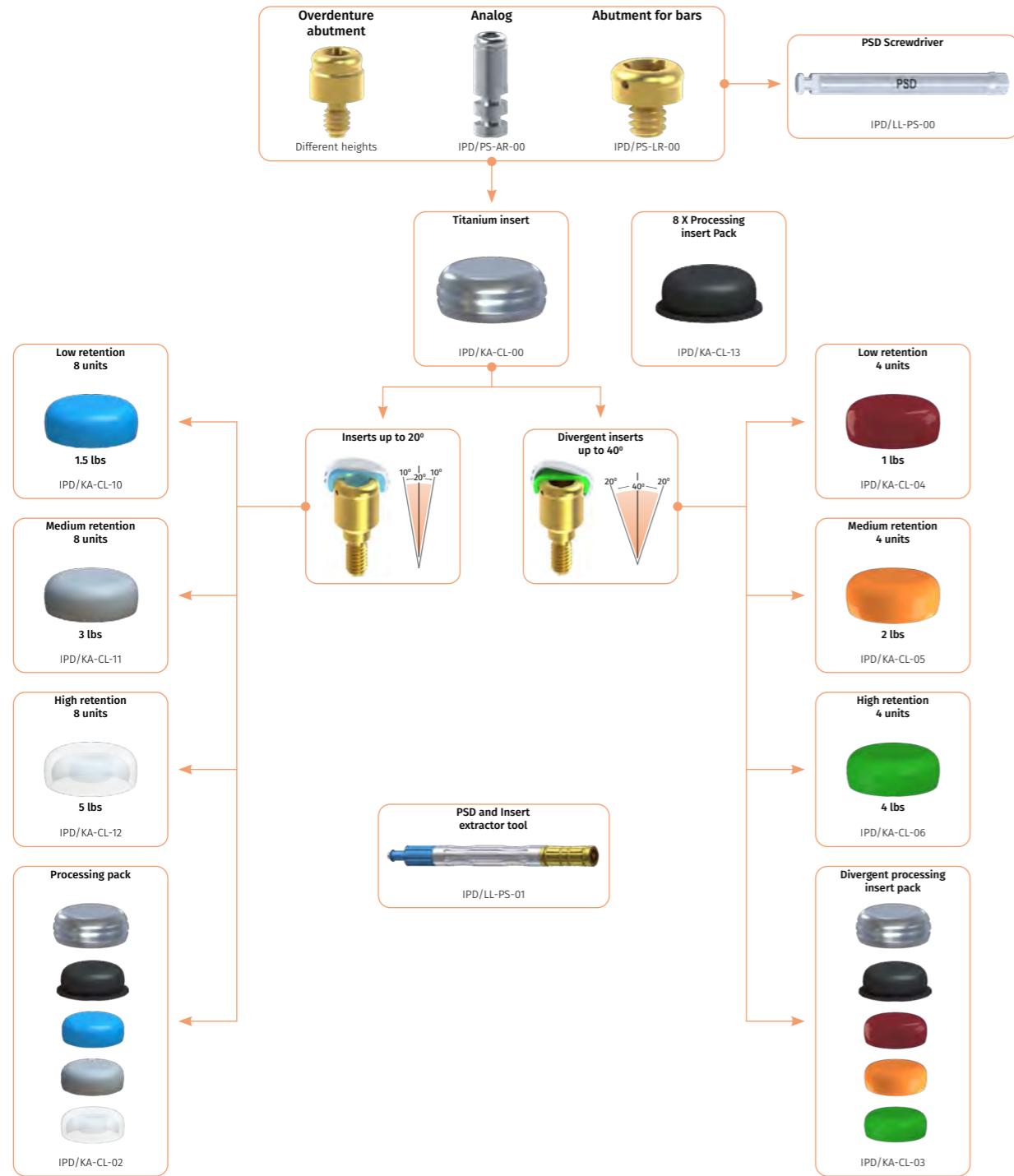

ANALOG

Description	Reference
PSD analog	IPD/PS-AR-00



TITANIUM INSERT

Description	Reference
Titanium insert	IPD/KA-CL-00
Titanium insert + 4 Retention inserts	IPD/KA-CL-02
Titanium insert + 4 Divergent Retention inserts	IPD/KA-CL-03



INSERTS

Description	Retention	Units	Reference
Combined inserts up to 20°	-	Pack 4	IPD/KA-CL-01
Red divergent inserts	1 lbs	Pack 4	IPD/KA-CL-04
Orange divergent inserts	2 lbs	Pack 4	IPD/KA-CL-05
Green divergent inserts	4 lbs	Pack 4	IPD/KA-CL-06
Inserts up to 20° in blue	1.5 lbs	Pack 8	IPD/KA-CL-10
Inserts up to 20° in grey	3 lbs	Pack 8	IPD/KA-CL-11
Inserts up to 20° colourless	5 lbs	Pack 8	IPD/KA-CL-12
Black processing inserts	-	Pack 8	IPD/KA-CL-13



ABUTMENT FOR BARS

Description	Height (mm)	Metric	Units	Reference
PSD abutment on bars	1	2 mm	2	IPD/PS-LR-00



PSD SCREWDRIVER

Description	Reference
PSD abutment screwdriver	IPD/LL-PS-00



PSD TOOL

Description	Reference
PSD Screwdriver + insert extractor tool	IPD/LL-PS-01



Compatibility	Platform	Height (mm)	Reference	
Nobel Biocare® Branemark System® Klockner® KL™	ø3.5	1	IPD/AA-LN-01	
		3	IPD/AA-LN-03	
		5	IPD/AA-LN-05	
Nobel Biocare® Branemark System® Biomet® 3i® Osseotite® BTI® Hex. Ext. Sweden & Martina® Outlink® Microdent® Microdent® Universal™ BioHorizons® External	ø4.1	1	IPD/AA-LR-01	
		2	IPD/AA-LR-02	
		3	IPD/AA-LR-03	
		4	IPD/AA-LR-04	
		5	IPD/AA-LR-05	
Phibo® TSH®	S3-S4			
Multi-unit	ø4.8	3.35	IPD/AB-LR-02	
Nobel Biocare® Nobel Replace® Select	ø4.3	ø3.5	IPD/AC-LN-03	
		5	IPD/AC-LN-05	
		1	IPD/AC-LR-01	
		3	IPD/AC-LR-03	
		5	IPD/AC-LR-05	
Nobel Biocare® Nobel Active®	ø3.5	1	IPD/AD-LN-01	
		2	IPD/AD-LN-02	
		3	IPD/AD-LN-03	
		4	IPD/AD-LN-04	
		5	IPD/AD-LN-05	
Nobel Biocare® Nobel Active®	ø4.3	1	IPD/AD-LR-01	
		2	IPD/AD-LR-02	
		3	IPD/AD-LR-03	
		4	IPD/AD-LR-04	
		5	IPD/AD-LR-05	
Biomet® 3i® Osseotite®	ø3.4	1	IPD/BA-LN-01	
		3	IPD/BA-LN-03	
		5	IPD/BA-LN-05	
Biomet® 3i® Certain®	ø3.4	1	IPD/BB-LN-01	
		3	IPD/BB-LN-03	
		5	IPD/BB-LN-05	
		ø4.1	1	IPD/BB-LR-01
			3	IPD/BB-LR-03
5	IPD/BB-LR-05			
Klockner® Essential Cone®	ø4.5	1	IPD/CB-LR-01	
		3	IPD/CB-LR-03	

Compatibility	Platform	Height (mm)	Reference	
Klockner® Vega®	ø3.5	1	IPD/CD-LN-01	
		2	IPD/CD-LN-02	
		3	IPD/CD-LN-03	
		4	IPD/CD-LN-04	
		5	IPD/CD-LN-05	
Klockner® Vega®	ø4.0 / ø4.5	1	IPD/CD-LR-01	
		2	IPD/CD-LR-02	
		3	IPD/CD-LR-03	
		4	IPD/CD-LR-04	
		5	IPD/CD-LR-05	
Straumann® Tissue Level	ø4.8	1	IPD/DA-LR-01	
		2	IPD/DA-LR-02	
		3	IPD/DA-LR-03	
		ø3.5	1	IPD/DB-LN-01
			2	IPD/DB-LN-02
3	IPD/DB-LN-03			
Straumann® Bone Level	ø4.1	4	IPD/DB-LN-04	
		5	IPD/DB-LN-05	
		1	IPD/DB-LR-01	
		2	IPD/DB-LR-02	
		4	IPD/DB-LR-04	
Straumann® BLX®	RB/WB	5	IPD/DB-LR-05	
		2	IPD/DC-LR-02	
		3	IPD/DC-LR-03	
		4	IPD/DC-LR-04	
Astra® Osseospeed™	ø3.5 / ø4.0	1	IPD/EA-LR-01	
		2	IPD/EA-LR-02	
		3	IPD/EA-LR-03	
		4	IPD/EA-LR-04	
		5	IPD/EA-LR-05	
Astra® Osseospeed™	ø4.5 / ø5.0	1	IPD/EA-LW-01	
		2	IPD/EA-LW-02	
		3	IPD/EA-LW-03	
		4	IPD/EA-LW-04	
		5	IPD/EA-LW-05	
Astra® Evolution®	ø4.2	1	IPD/EB-LR-01	
		3	IPD/EB-LR-03	
		5	IPD/EB-LR-05	

Compatibility	Platform	Height (mm)	Reference
Zimmer® Screw Vent® BioHorizons® Tapered Internal	ø3.5	1	IPD/FA-LN-01
		2	IPD/FA-LN-02
		3	IPD/FA-LN-03
		4	IPD/FA-LN-04
		5	IPD/FA-LN-05
	ø4.5	1	IPD/FA-LR-01
		2	IPD/FA-LR-02
		3	IPD/FA-LR-03
		4	IPD/FA-LR-04
		5	IPD/FA-LR-05
Zimmer® Eztetic®	ø3.1	2	IPD/FC-LT-02
		3	IPD/FC-LT-03
		4	IPD/FC-LT-04
BTI® Internal Universal®	ø4.1	1	IPD/GB-LR-01
		3	IPD/GB-LR-03
		5	IPD/GB-LR-05
Camlog® Camlog®	ø3.8	1	IPD/JA-LR-01
		3	IPD/JA-LR-03
		5	IPD/JA-LR-05
BioHorizons® Tapered Internal	ø3.0	2	IPD/LB-LT-02
		3	IPD/LB-LT-03
		4	IPD/LB-LT-04
		5	IPD/LB-LT-05
		2	IPD/MA-LN-02
Sweden & Martina® Outlink®	ø3.3	3	IPD/MA-LN-03
		4	IPD/MA-LN-04
		5	IPD/MA-LN-05
		1	IPD/MB-LN-01
		3	IPD/MB-LN-03
Sweden & Martina® Premium™ Kohno®	ø3.8	5	IPD/MB-LN-05
		1	IPD/MB-LR-01
		3	IPD/MB-LR-03
	ø4.25	5	IPD/MB-LR-05
		1	IPD/NA-LN-01
Phibo® TSH®	S2	3	IPD/NA-LN-03

Compatibility	Platform	Height (mm)	Reference
Osstem Implant® TSIII	ø3.5	1	IPD/OB-LN-01
		2	IPD/OB-LN-02
		3	IPD/OB-LN-03
		4	IPD/OB-LN-04
		5	IPD/OB-LN-05
	ø4.0	1	IPD/OB-LR-01
		2	IPD/OB-LR-02
		3	IPD/OB-LR-03
		4	IPD/OB-LR-04
		5	IPD/OB-LR-05
Biotech® Dental Kontakt®	RP	2	IPD/QB-LR-02
		3	IPD/QB-LR-03
		4	IPD/QB-LR-04
		2	IPD/RB-LR-02
Neodent® Grand Morse™ GM	GM	3	IPD/RB-LR-03
		4	IPD/RB-LR-04
		1	IPD/SB-LN-01
		2	IPD/SB-LN-02
Bego® Semados®	ø3.25 / ø3.75	3	IPD/SB-LN-03
		4	IPD/SB-LN-04
		5	IPD/SB-LN-05
		1	IPD/SB-LR-01
		2	IPD/SB-LR-02
	ø4.1	3	IPD/SB-LR-03
		4	IPD/SB-LR-04
		5	IPD/SB-LR-05
		1	IPD/SB-LW-01
		2	IPD/SB-LW-02
MIS® Seven®	ø4.5	3	IPD/SB-LW-03
		4	IPD/SB-LW-04
		5	IPD/SB-LW-05
		1	IPD/TA-LT-01
		2	IPD/TA-LT-02
MIS® C1/V3®	Standard ø3.75 / ø4.20	3	IPD/TA-LT-03
		4	IPD/TA-LT-04
		5	IPD/TA-LT-05
		1	IPD/TB-LR-01
		2	IPD/TB-LR-02

Compatibility	Platform	Height (mm)	Reference
DIO® UFII	NP	2	IPD/UB-LN-02
		3	IPD/UB-LN-03
		4	IPD/UB-LN-04
	RP	2	IPD/UB-LR-02
		3	IPD/UB-LR-03
		4	IPD/UB-LR-04
Megagen® AnyOne®	RP	2	IPD/WA-LR-02
		3	IPD/WA-LR-03
		4	IPD/WA-LR-04
		2	IPD/WB-LR-02
Megagen® AnyRidge®	RP	3	IPD/WB-LR-03
		4	IPD/WB-LR-04
		2	IPD/XA-LR-02
		3	IPD/XA-LR-03
Dentium® Implantium® / Superline™	RP	4	IPD/XA-LR-04
		2	IPD/YB-LR-02
		3	IPD/YB-LR-03
Medentis® ICX	RP	4	IPD/YB-LR-03

WOKRFLOW DIAGRAM

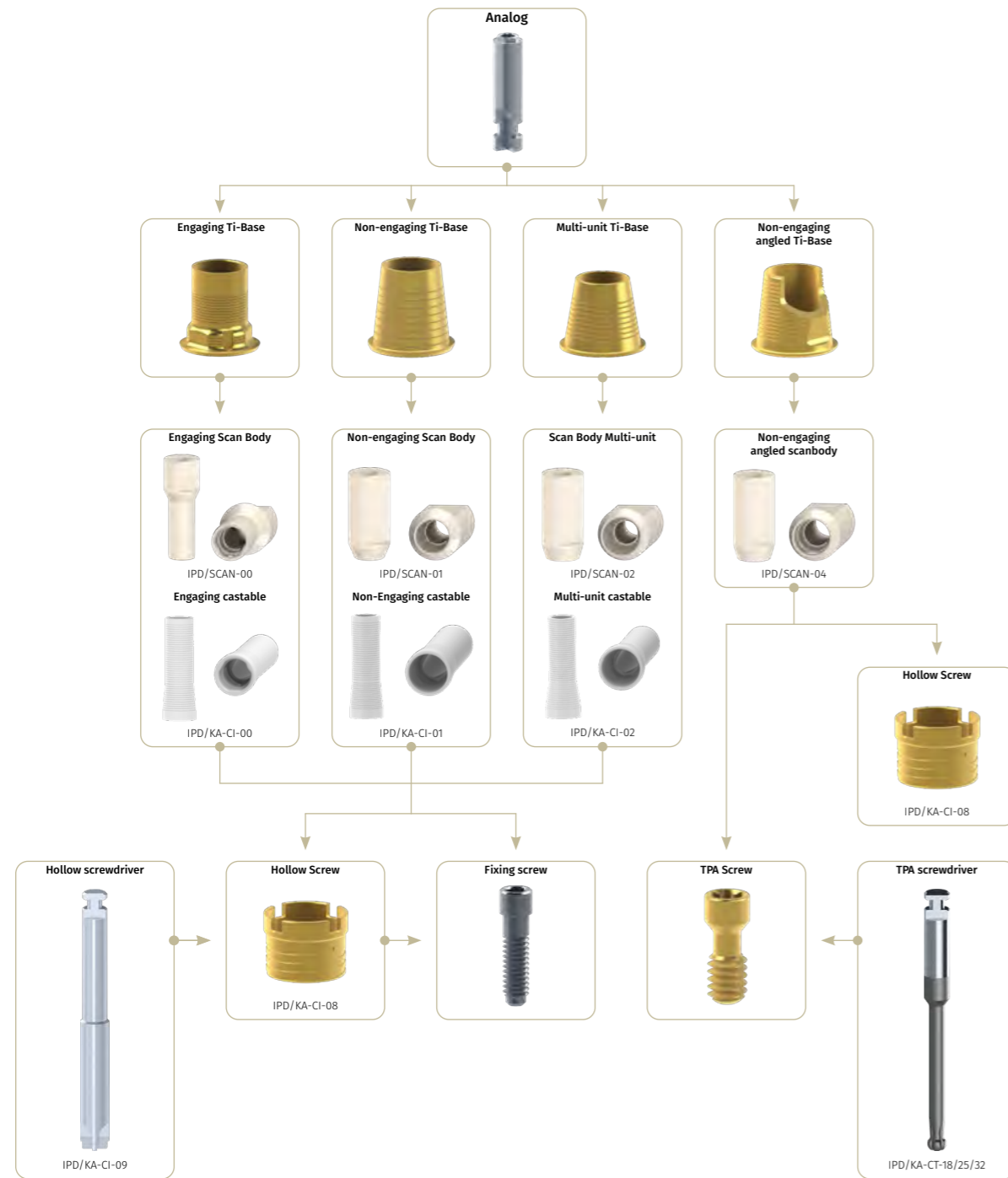

SCAN BODY

Engaging and Non-engaging

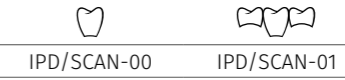

Multi-unit

Reference

IPD/SCAN-02



Non-engaging angled

Reference

IPD/SCAN-04



CASTABLE

Engaging and Non-engaging



Multi-unit

Reference

IPD/KA-CI-02



HOLLOW SCREW

Reference

IPD/KA-CI-08



HOLLOW SCREWDRIVER

Reference

IPD/KA-CI-09



Compatibility	Platform	Connection	Model	Height (mm)	Reference
Nobel Biocare® Branemark System® Biomet® 3i® Osseotite® BTI® Hex. Ext. Sweden & Martina® Outlink® Microdent® Microdent® Universal™ Klockner® KL™	ø4.1	Engaging	Straight	0.2	IPD/AA-IR-00
				1.5	IPD/AA-IR-02
		Non-engaging		2.5	IPD/AA-IR-04
				0.2	IPD/AA-IR-01
				1.5	IPD/AA-IR-03
Phibo® TSH®	S3-S4	For angulations	0.2	IPD/AA-IR-31	
			2.5	IPD/AA-IR-05	
Nobel Biocare® Branemark System® Klockner® KL™	ø3.5	Engaging	Straight	1.0	IPD/AA-IN-00
				2.5	IPD/AA-IN-02
		Non-engaging		1.0	IPD/AA-IN-01
				2.5	IPD/AA-IN-03
				1.0	IPD/AA-IN-31
Multi-unit	Non-engaging	Straight	0.2	IPD/AB-IR-01	
			1.0	IPD/AC-IN-00	
ø3.5	Engaging	Straight	2.5	IPD/AC-IN-02	
			1.0	IPD/AC-IN-01	
			Non-engaging	2.5	IPD/AC-IN-03
				3.5	IPD/AC-IN-31
				0.2	IPD/AC-IR-00
Nobel Biocare® Nobel Replace® Select	ø4.3	Engaging	Straight	1.5	IPD/AC-IR-02
				2.5	IPD/AC-IR-04
		Non-engaging		0.2	IPD/AC-IR-01
				1.5	IPD/AC-IR-03
				2.5	IPD/AC-IR-05
ø5.0	Engaging	Straight	0.2	IPD/AC-IW-00	
			1.5	IPD/AC-IW-02	
			Non-engaging	2.5	IPD/AC-IW-04
				0.2	IPD/AC-IW-01
				1.5	IPD/AC-IW-03
For angulations	2.5	IPD/AC-IW-05			
	0.2	IPD/AC-IW-31			
Nobel Biocare® Nobel Active®	ø3.5	Engaging	Straight	0.9	IPD/AD-IN-00
				2.5	IPD/AD-IN-02
		Non-engaging		0.9	IPD/AD-IN-01
				2.5	IPD/AD-IN-03
				0.9	IPD/AD-IN-31

Compatibility	Platform	Connection	Model	Height (mm)	Reference
Nobel Biocare® Nobel Active®	ø4.3	Engaging	Straight	0.9	IPD/AD-IR-00
				2.5	IPD/AD-IR-02
		Non-engaging		0.9	IPD/AD-IR-01
				2.5	IPD/AD-IR-03
				1.0	IPD/AD-IR-31
Biomet® 3i® Osseotite®	ø5.0	Engaging	Straight	1.0	IPD/BA-IN-00
				2.5	IPD/BA-IN-02
		Non-engaging		1.0	IPD/BA-IN-01
				2.5	IPD/BA-IN-03
				1.0	IPD/BA-IN-31
ø3.4	Engaging	Straight	0.2	IPD/BA-IW-00	
			1.5	IPD/BA-IW-02	
			Non-engaging	2.5	IPD/BA-IW-04
				0.2	IPD/BA-IW-01
				1.5	IPD/BA-IW-03
For angulations	2.5	IPD/BA-IW-05			
	0.2	IPD/BA-IW-31			
Biomet® 3i® Certain®	ø4.1	Engaging	Straight	0.9	IPD/BB-IN-00
				2.5	IPD/BB-IN-02
		Non-engaging		0.9	IPD/BB-IN-01
				2.5	IPD/BB-IN-03
				0.9	IPD/BB-IN-31
ø4.1	Engaging	Straight	0.3	IPD/BB-IR-00	
			1.5	IPD/BB-IR-02	
			Non-engaging	2.5	IPD/BB-IR-04
				0.3	IPD/BB-IR-01
				1.5	IPD/BB-IR-03
For angulations	2.5	IPD/BB-IR-05			
	0.3	IPD/BB-IR-31			
Biomet® 3i® Certain®	ø5.0	Engaging	Straight	0.3	IPD/BB-IW-00
				1.5	IPD/BB-IW-02
		Non-engaging		2.5	IPD/BB-IW-04
				0.3	IPD/BB-IW-01
				1.5	IPD/BB-IW-03
For angulations	2.5	IPD/BB-IW-05			
	0.9	IPD/BB-IW-31			
Klockner® Essential Cone®	ø4.5	Engaging	Straight	0.3	IPD/CB-IR-00
				0.3	IPD/CB-IR-01
		Non-engaging		For angulations	0.35

Compatibility	Platform	Connection	Model	Height (mm)	Reference
Straumann® Tissue Level	ø4.8	Engaging	Straight	0.85	IPD/DA-IR-00
		Non-engaging			IPD/DA-IR-01
		For angulations	IPD/DA-IR-11		
			IPD/DA-IR-31		
Straumann® Bone Level	ø3.3 NC	Engaging	Straight	1.0	IPD/DB-IN-00
		Non-engaging		2.5	IPD/DB-IN-02
		For angulations	1.0	IPD/DB-IN-01	
			2.5	IPD/DB-IN-03	
	ø4.1 RC	Engaging	Straight	1.0	IPD/DB-IN-31
		2.5		IPD/DB-IR-00	
		For angulations	2.5	IPD/DB-IR-02	
			1.0	IPD/DB-IR-01	
Astra® Osseospeed™	ø3.0	Engaging	Straight	1.5	IPD/EA-IN-00
		2.5		IPD/EA-IN-02	
		For angulations	1.5	IPD/EA-IN-01	
			2.5	IPD/EA-IN-03	
	ø3.5/4.0	Engaging	Straight	1.5	IPD/EA-IN-31
		1.1		IPD/EA-IR-00	
		For angulations	2.5	IPD/EA-IR-02	
			1.1	IPD/EA-IR-01	
Astra® Osseospeed™	ø4.5/5.0	Engaging	Straight	2.5	IPD/EA-IR-03
		1.1		IPD/EA-IR-31	
		For angulations	0.9	IPD/EA-IW-00	
			2.5	IPD/EA-IW-02	
	ø3.6	Engaging	Straight	0.9	IPD/EA-IW-01
		2.5		IPD/EA-IW-03	
		For angulations	0.9	IPD/EA-IW-31	
			0.9	IPD/EA-IW-01	
Astra® Evolution®	ø3.6	Engaging	Straight	1.0	IPD/EB-IN-00
		Non-engaging			IPD/EB-IN-01
		For angulations	IPD/EB-IN-31		
	ø4.2	Engaging	Straight		IPD/EB-IR-00
		Non-engaging			IPD/EB-IR-01
		For angulations	IPD/EB-IR-31		

Compatibility	Platform	Connection	Model	Height (mm)	Reference	
Zimmer® Screw Vent®	ø3.5	Engaging	Straight	0.9	IPD/FA-IN-00	
		2.5		IPD/FA-IN-02		
		For angulations	0.9	IPD/FA-IN-01		
			2.5	IPD/FA-IN-03		
			0.9	IPD/FA-IN-31		
	ø4.5	Engaging	Straight	0.1	IPD/FA-IR-00	
		1.5		IPD/FA-IR-02		
		For angulations	2.5	IPD/FA-IR-04		
			0.1	IPD/FA-IR-01		
			1.5	IPD/FA-IR-03		
BTI® Tiny BTI®	ø3.5	Engaging	Straight	2.5	IPD/FA-IR-05	
		0.1		IPD/FA-IR-31		
		For angulations	1.0	IPD/GA-IN-00		
			2.5	IPD/GA-IN-02		
	ø5.5	Engaging	Straight	1.0	IPD/GA-IN-01	
		2.5		IPD/GA-IN-03		
		For angulations	1.0	IPD/GA-IN-31		
			1.6	IPD/GA-IN-00		
BTI® External Wide	ø5.5	Engaging	Straight	1.6	IPD/GA-IW-00	
		2.5		IPD/GA-IW-01		
		For angulations	1.6	IPD/GA-IW-01		
			2.5	IPD/GA-IW-31		
	BTI® Internal Universal®	ø5.5	Engaging	Straight	0.3	IPD/GA-IW-31
			1.5		IPD/GB-IR-00	
			For angulations	0.3	IPD/GB-IR-02	
				2.5	IPD/GB-IR-04	
ø3.4		Engaging	Straight	0.3	IPD/GB-IR-01	
		1.5		IPD/GB-IR-03		
		For angulations	2.5	IPD/GB-IR-05		
			0.3	IPD/GB-IR-31		
Dentsply® Xive® Friadent®	ø3.8	Engaging	Straight	1.0	IPD/IA-IN-00	
		2.5		IPD/IA-IN-01		
		For angulations	1.0	IPD/IA-IN-31		
			0.5	IPD/IA-IR-00		
	ø4.5	Engaging	Straight	0.5	IPD/IA-IR-01	
		2.5		IPD/IA-IR-31		
		For angulations	0.5	IPD/IA-IR-01		
			0.3	IPD/IA-IW-00		

Compatibility	Platform	Connection	Model	Height (mm)	Reference
Dentsply® Ankylos®	C/X	Engaging	Straight	1.0	IPD/IB-IR-00
				2.0	IPD/IB-IR-02
		Non-engaging	For angulations	1.0	IPD/IB-IR-01
				2.0	IPD/IB-IR-03
				1.0	IPD/IB-IR-31
Camlog® Camlog®	ø3.3	Engaging	Straight	1.0	IPD/JA-IN-00
		Non-engaging		IPD/JA-IN-01	
	ø3.8	Engaging	Straight	0.7	IPD/JA-IR-00
		Non-engaging		IPD/JA-IR-01	
	ø4.3	Engaging	For angulations	0.3	IPD/JA-IW-00
		Non-engaging		IPD/JA-IW-01	
BioHorizons® Tapered Internal	ø3.5	Engaging	Straight	0.9	IPD/LB-IN-00
		Non-engaging		IPD/LB-IN-01	
		For angulations		IPD/LB-IN-31	
	ø4.5	Engaging	Straight	0.1	IPD/LB-IR-00
		Non-engaging		IPD/LB-IR-01	
		For angulations	IPD/LB-IR-31		
Sweden & Martina® Premium™ Kohno®	ø3.8	Engaging	Straight	0.7	IPD/MB-IN-00
		Non-engaging		IPD/MB-IN-01	
		For angulations		0.65	IPD/MB-IN-31
	ø4.25	Engaging	Straight	0.7	IPD/MB-IR-00
		Non-engaging		IPD/MB-IR-01	
		For angulations	0.65	IPD/MB-IR-31	
Phibo® TSH®	S2	Engaging	Straight	1.0	IPD/NA-IN-00
		Non-engaging		IPD/NA-IN-01	
		For angulations	IPD/NA-IN-31		
Megagen® AnyRidge®	4.2	Engaging	Straight	1.0	IPD/WB-IR-00



1.00 HEX SCREWDRIVER

Lengths (mm)	Reference
18	IPD/PH-00-18
25	IPD/PH-00-25
32	IPD/PH-00-32



1.20 HEX SCREWDRIVER

Lengths (mm)	Reference
18	IPD/PH-20-18
25	IPD/PH-20-25
32	IPD/PH-20-32



1.25 HEX SCREWDRIVER

Lengths (mm)	Reference
18	IPD/PH-25-18
25	IPD/PH-25-25
32	IPD/PH-25-32



1.27 HEX SCREWDRIVER

Lengths (mm)	Reference
18	IPD/PH-27-18
25	IPD/PH-27-25
32	IPD/PH-27-32



1.40 HEX SCREWDRIVER

Lengths (mm)	Reference
18	IPD/PH-40-18
25	IPD/PH-40-25
32	IPD/PH-40-32



1.70 HEX SCREWDRIVER

Lengths (mm)	Reference
18	IPD/PH-70-18
25	IPD/PH-70-25
32	IPD/PH-70-32



1.25 SQUARE SCREWDRIVER

Lengths (mm)	Reference
18	IPD/PC-25-18
25	IPD/PC-25-25
32	IPD/PC-25-32



STAR SCREWDRIVER (Klockner Essential® / Vega®)

Lengths (mm)	Reference
18	IPD/PS-00-18
25	IPD/PS-00-25
32	IPD/PS-00-32



UNIGRIP SCREWDRIVER

Lengths (mm)	Reference
18	IPD/PU-00-18
25	IPD/PU-00-25
32	IPD/PU-00-32



NEO GM SCREWDRIVER

Lengths (mm)	Reference
18	IPD/PU-01-18
25	IPD/PU-01-25
32	IPD/PU-01-32



FLAT SCREWDRIVER

Lengths (mm)	Reference
18	IPD/PP-00-18
25	IPD/PP-00-25
32	IPD/PP-00-32



TORX SCREWDRIVER

Lengths (mm)	Reference
18	IPD/PT-00-18
25	IPD/PT-00-25
32	IPD/PT-00-32



MULTI-UNIT SCREWDRIVER

Lengths (mm)	Reference
20	IPD/LL-AB-00



PSD SCREWDRIVER

Lengths (mm)	Reference
25	IPD/LL-PS-00

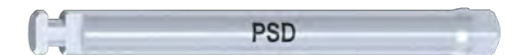

PSD AND INSERT EXTRACTOR TOOL

Reference
IPD/LL-PS-01



HOLLOW SCREWDRIVER

Lengths (mm)	Reference
26	IPD/KA-CI-09



TPA SCREWDRIVER

Lengths (mm)	Reference
18	IPD/KA-CT-18
25	IPD/KA-CT-25
32	IPD/KA-CT-32



CLINICAL RA SHANK HANDLE

Lengths (mm)	Reference
16	IPD/MC-00-16



LABORATORY RA SHANK HANDLE

Lengths (mm)	Reference
70	IPD/ML-00-70



RA SHANK RATCHET

Lengths (mm)	Reference
90	IPD/DI-00-90

Adapter included.



RATCHET ADAPTER

Description	Reference
Ratchet adapter	IPD/DI-KA-90



Description	Reference	
	IPD/KT-DI-18	IPD/KT-DI-25
	Lengths	
1.20 Hex Screwdriver	18 mm	25 mm
1.25 Hex Screwdriver	18 mm	25 mm
1.27 Hex Screwdriver	18 mm	25 mm
1.70 Hex Screwdriver	18 mm	25 mm
1.25 Square screwdriver	18 mm	25 mm
Unigrip screwdriver	18 mm	25 mm
Flat screwdriver	18 mm	25 mm
TPA screwdriver	18 mm	25 mm
Torx screwdriver	18 mm	25 mm
Multi-unit screwdriver	20 mm	20 mm
RA Shank Ratchet	90 mm	90 mm



Description	Reference	
	IPD/KT-MC-18	IPD/KT-MC-25
	Lengths	
1.20 Hex Screwdriver	18 mm	25 mm
1.25 Hex Screwdriver	18 mm	25 mm
1.27 Hex Screwdriver	18 mm	25 mm
1.70 Hex Screwdriver	18 mm	25 mm
1.25 Square screwdriver	18 mm	25 mm
Unigrip screwdriver	18 mm	25 mm
Flat screwdriver	18 mm	25 mm
TPA screwdriver	18 mm	25 mm
Torx screwdriver	18 mm	25 mm
Multi-unit screwdriver	20 mm	20 mm
Clinical RA Shank Handle	16 mm	16 mm



Description	Reference
	IPD/KT-ML-32
	Lengths
1.20 Hex Screwdriver	32 mm
1.25 Hex Screwdriver	32 mm
1.27 Hex Screwdriver	32 mm
1.70 Hex Screwdriver	32 mm
1.25 Square screwdriver	32 mm
Unigrip screwdriver	32 mm
Flat screwdriver	32 mm
TPA screwdriver	32 mm
Torx screwdriver	32 mm
Laboratory RA Shank Handle	70 mm



DESCRIPTION				CHARACTERISTIC							
REFERENCE	TIN REFERENCE	COMPATIBILITY	PLATFORM	SEAT	HEAD DIAMETER	METRIC	HEAD (L1)	BODY (L2)	TOTAL (LT)	SCREWDRIVER	TORQUE (Ncm)
IPD/AA-TN-00	IPD/AA-TN-00/TIN	Nobel Biocare® Branemark System®	Ø3.5	70°	2.25	M1.6x0.35	2.15	5.15	7.30	Unigrip	35
		Nobel Biocare® Nobel Active®	Ø3.5								
IPD/AA-TR-00	IPD/AA-TR-00/TIN	Nobel Biocare® Branemark System®	Ø4.1	75°	2.4	M2x0.4	1.5	5.85	7.35	Unigrip	35
		Nobel Biocare® Nobel Active®	Ø4.3								
IPD/AA-TR-01	IPD/AA-TR-01/TIN	External Hex (Plat. Regular)	Ø4.1	75°	2.5	M2x0.4	1.67	4.6	6.27	120 Hex	20
IPD/AA-TR-02	IPD/AA-TR-02/TIN	Nobel Biocare® Branemark System®	Ø4.1	Flat	2.40	M2x0.4	1.45	5.9	7.35	Unigrip	35
		Nobel Biocare® Nobel Active®	Ø4.3								
IPD/AA-TW-00	IPD/AA-TW-00/TIN	Nobel Biocare® Branemark System®	Ø5.1	72°	3.40	M2.5x0.45	1.37	5.33	6.7	Unigrip	35
IPD/AB-TR-00	IPD/AB-TR-00/TIN	Multi-unit	Ø4.8	Flat	2.00	M1.4x0.3	1.35	2.1	3.45	Unigrip	15
IPD/AC-TN-00	IPD/AC-TN-00/TIN	Nobel Biocare® Nobel Replace® Select	Ø3.5	Flat	2.35	M1.8x0.35	1.8	6.5	8.3	Unigrip	35
IPD/AC-TR-00	IPD/AC-TR-00/TIN	Nobel Biocare® Nobel Replace® Select	Ø4.3 / Ø5.0	Flat	2.4	M2x0.4	1.55	8.35	9.9	Unigrip	35
IPD/AD-TT-00	IPD/AD-TT-00/TIN	Nobel Biocare® Nobel Active®	Ø3.0	70°	1.82	M1.4x0.3	1.86	4.84	6.7	Unigrip	15
IPD/BA-TR-00	IPD/BA-TR-00/TIN	Biomet® 3i® Osseotite® (Plat. R)	Ø4.1	75°	2.35	M2x0.4	1.79	5.81	7.6	120 Hex	20
IPD/BA-TR-01	IPD/BA-TR-01/TIN	Biomet® 3i® Osseotite® (Plat. R)	Ø4.1	75°	2.35	M2x0.4	1.79	5.81	7.6	125 Hex	25
IPD/BA-TR-02	IPD/BA-TR-02/TIN	Biomet® 3i® Osseotite®	Ø3.4 / Ø4.1 / Ø5.0	Flat	2.4	M2x0.4	1.65	6.15	7.8	Square	35
IPD/BB-TR-01	IPD/BB-TR-01/TIN	Biomet® 3i® Certain®	Ø3.4 / Ø4.1 / Ø5.0	Flat	2.0	M1.6x0.35	1.9	6.5	8.4	120 Hex	20
IPD/BB-TR-02	-	Biomet® 3i® Certain®	Ø4.1 / Ø5.0	140°	2.30	M1.6x0.35	2.05	6.35	8.4	120 Hex	20
IPD/CA-TR-00	IPD/CA-TR-00/TIN	Klockner® SK2-NK2	Ø4.2	90°	2.45	M1.8x0.35	2.39	3.56	5.95	1.70 Hex	30
IPD/CA-TR-01	IPD/CA-TR-01/TIN	Klockner® SK2-NK2	Ø4.2	90°	2.45	M1.8x0.35	0.72	3.58	4.3	Cross	30
IPD/CB-TR-00	IPD/CB-TR-00/TIN	Klockner® Essential Cone®	Ø4.5	90°	2.18	M1.8x0.35	2.3	4.9	7.2	Star	30
IPD/CD-TN-00	IPD/CD-TN-00/TIN	Klockner® Vega®	Ø3.5	90°	2.15	M1.6x0.35	2.43	5.57	8	Star	25
IPD/CD-TR-00	IPD/CD-TR-00/TIN	Klockner® Vega®	Ø4.0-4.5	90°	2.15	Special	2.32	5.68	8	Star	25
IPD/DA-TR-00	IPD/DA-TR-00/TIN	Straumann® Tissue Level (synOcta® level)	Ø4.8	90°	2.4	M2x0.4	1.2	3.3	4.5	Torx	35
IPD/DA-TR-01	IPD/DA-TR-01/TIN	Straumann® Tissue Level (Implant level)	Ø4.8 / Ø6.5	30°	2.4	M2x0.4	3.03	3.67	6.7	Torx	35
IPD/DA-TR-02	-	Straumann® Tissue Level	Ø4.8	Flat	2.52	M2x0.4	1.45	5.9	7.35	Torx	35
IPD/DA-TR-03	-	Straumann® Tissue Level	Ø4.8	30°	2.57	M2x0.4	3.05	3.65	6.7	Torx	35
IPD/DB-TR-00	IPD/DB-TR-00/TIN	Straumann® Bone Level	Ø3.3 / Ø4.1	30°	2.1	M1.6x0.35	2.31	5.54	7.85	Torx	35
IPD/DC-TR-00	IPD/DC-TR-00/TIN	Straumann® BLX®	RB/WB	90°	2.1	M1.6x0.35	1.5	4.6	6.1	Torx	30
IPD/EA-TN-00	IPD/EA-TN-00/TIN	Astra® Osseospeed™	Ø3.0	120°	2.1	M1.4x0.3	2	5.5	7.5	127 Hex	15
IPD/EA-TR-00	IPD/EA-TR-00/TIN	Astra® Osseospeed™	Ø3.5 - Ø4.0	Flat	2.35	M1.6x0.35	1.95	6.3	8.25	127 Hex	20
IPD/EA-TR-01	IPD/EA-TR-01/TIN	Astra® Cono 20°	Ø3.5-Ø4.0 / Ø4.5-Ø5.0	Flat	2.25	M1.4x0.3	1.85	2.95	4.8	127 Hex	15
IPD/EA-TW-00	IPD/EA-TW-00/TIN	Astra® Osseospeed™	Ø4.5 - Ø5.0	Flat	2.35	M2x0.4	1.9	8.4	10.3	127 Hex	25
IPD/EB-TN-00	IPD/EB-TN-00/TIN	Astra® Evolution®	Ø3.6	60°	2.15	M1.6x0.35	2.12	5.33	7.45	127 Hex	20
IPD/EB-TR-00	IPD/EB-TR-00/TIN	Astra® Evolution®	Ø4.2	100°	2.35	M1.8x0.35	1.92	5.70	7.62	127 Hex	20
IPD/FA-TR-00	IPD/FA-TR-00/TIN	Zimmer® Screw Vent®	Ø3.5 / Ø4.5 / Ø5.7	140°	2.1	M1.8x0.35	2.54	5.66	8.2	125 Hex	30
IPD/FB-TR-00	IPD/FB-TR-00/TIN	Zimmer® SwissPlus®	Ø4.8	140°	2.3	M2x0.4	2.55	6.75	9.3	125 Hex	30
IPD/FB-TR-01	IPD/FB-TR-01/TIN	Zimmer® SwissPlus®	Ø4.8	30°	2.4	M2x0.4	3.03	3.87	6.9	125 Hex	30
IPD/FC-TT-00	IPD/FC-TT-00/TIN	Zimmer® Eztetic®	Ø3.1	140°	1.95	M1.6x0.35	2.81	5.94	8.75	125 Hex	30

DESCRIPTION				CHARACTERISTIC							
REFERENCE	TIN REFERENCE	COMPATIBILITY	PLATFORM	SEAT	HEAD DIAMETER	METRIC	HEAD (L1)	BODY (L2)	TOTAL (LT)	SCREWDRIVER	TORQUE (Ncm)
IPD/GA-TN-00	IPD/GA-TN-00/TIN	BTI® External Hex	Ø3.5	Flat	2.35	M2x0.4	1.7	3.85	5.55	120 Hex	20
IPD/GA-TW-00	IPD/GA-TW-00/TIN	BTI® External Hex	Ø5.5	Flat	2.25	M2x0.4	1.7	6.15	7.85	120 Hex	20
IPD/GB-TR-00	IPD/GB-TR-00/TIN	BTI® Internal Universal®	Universal® Ø4.1 / Wide Ø5.5	Flat	2.4	M1.8x0.35	1.85	5.2	7.05	120 Hex	20
IPD/GC-TR-01	IPD/GC-TR-01/TIN	BTI® Multi-im®	RP	Flat	2.0	M1.4x0.3	1.5	2.1	3.6	120 Hex	20
IPD/HA-TN-00	IPD/HA-TN-00/TIN	Microdent® Microdent® System	Ø3.5	140°	2.5	M1.8x0.35	2.13	3.87	6	120 Hex	20
IPD/HA-TR-00	IPD/HA-TR-00/TIN	Microdent® Microdent® System	Ø4.2 / Ø5.1	120°	2.7	M2x0.4	2.5	5.5	8	1.75 Hex	30
IPD/IA-TR-00	IPD/IA-TR-00/TIN	Dentsply® Xive® Friadent®	Ø3.4 / Ø3.8 / Ø4.5	90°	2.05	M1.6x0.35	2.1	6.75	8.85	120 Hex	24
IPD/IB-TR-00	-	Dentsply® Ankylos® Balance Base Narrow	C/X	60°	2.4	M1.6x0.35	1.66	3.04	4.7	1.0 Hex	15
IPD/IB-TR-01	-	Dentsply® Ankylos®	C/X	60°	2.05	M1.8x0.35	2	6.15	8.15	1.0 Hex	25
IPD/ID-TT-00	-	Osteoplus® Iridium™ Argentum®	Ø3.3 / Ø3.8 / Ø4.2 / Ø4.8	120°	2.40	M1.8x0.35	1.69	5.83	7.52	1.25 Hex	25
IPD/JA-TR-00	IPD/JA-TR-00/TIN	Camlog® Camlog® Implant System	Ø3.3 / Ø3.8 / Ø4.3	90°	2.1	M1.6x0.35	2.35	8.1	10.45	1.25 Hex	20
IPD/KA-CI-08	-	Hollow Screw	-	Flat	2.8	M2.65x0.3	0.7	1.4	2.1	IPD cross	10
IPD/LB-TR-00	IPD/LB-TR-00/TIN	BioHorizons® Tapered Internal	Ø3 / Ø3.5 / Ø4.5 / Ø5.7	90°	2.35	M1.8x0.35	2.42	4.83	7.25	1.27 Hex	35
IPD/MA-TN-00	IPD/MA-TN-00/TIN	Sweden & Martina® Outlink®	Ø3.3	120°	2.18	M1.8x0.35	1.75	5.75	7.5	1.27 Hex	25
IPD/MB-TN-00	IPD/MB-TN-00/TIN	Sweden & Martina® Premium™ Kohno®	Ø3.3 / Ø3.8	120°	2.2	M1.8x0.35	1.78	6.32	8.1	1.27 Hex	25
IPD/MB-TR-00	IPD/MB-TR-00/TIN	Sweden & Martina® Premium™ Kohno®	Ø4.25 / Ø5.0	120°	2.4	M2x0.4	1.78	6	7.78	1.27 Hex	25
IPD/NA-TN-00	IPD/NA-TN-00/TIN	Phibo® TSH®	S2	120°	2.23	M1.8x0.35	1.92	6.08	8	1.25 Hex	35
IPD/NA-TW-00	-	Phibo® TSH®	S5	120°	2.5	M2x0.4	2.5	5.5	8	1.25 Hex	35
IPD/OB-TN-00	IPD/OB-TN-00/TIN	Osstem Implant® TSIII	Ø3.5	90°	2.20	M1.6x0.35	2.41	7.79	10.2	120 Hex	20
IPD/OB-TR-00	IPD/OB-TR-00/TIN	Osstem Implant® TSIII	Ø4.0	90°	2.30	M2x0.4	2.23	6.12	8.35	120 Hex	30
IPD/QB-TR-00	IPD/QB-TR-00/TIN	Biotech® Dental Kontakt®	RP	90°	1.95	M1.4x0.3	1.8	6.02	7.82	120 Hex	20
IPD/RB-TR-00	IPD/RB-TR-00/TIN	Neodent® Grand Morse™ GM	RP	60°	1.86	M1.6x0.35	1.84	7.93	9.77	Unigrip GM	20
IPD/SB-TR-00	IPD/SB-TR-00/TIN	Bego® Semados®	Ø3.25-3.75 / Ø4.1 / Ø4.5	70°	2.35	M1.8x0.35	2.35	5.25	7.6	1.25 Hex	30
IPD/TA-TT-00	IPD/TA-TT-00/TIN	MIS® Seven®	Narrow 3.3	120°	2.1	M1.6x0.35	2.58	5.1	7.68	1.25 Hex	30
IPD/TB-TR-00	IPD/TB-TR-00/TIN	MIS® C1/V3®	Standard	120°	2.2	UNF 1-72	2.44	5.18	7.62	1.25 Hex	30
IPD/UB-TN-00	IPD/UB-TN-00/TIN	DIO® UFII	NP	90°	1.85	M1.4x0.3	2.05	5.45	7.5	120 Hex	20
IPD/UB-TR-00	IPD/UB-TR-00/TIN	DIO® UFII	RP	120°	2.45	M2x0.4	1.95	6.55	8.5	120 Hex	30
IPD/WA-TR-00	IPD/WA-TR-00/TIN	Megagen® AnyOne®	RP	120°	2.3	M2x0.4	1.9	8.0	9.9	120 Hex	35
IPD/WB-TR-00	IPD/WB-TR-00/TIN	Megagen® AnyRidge®	RP	Flat	2.1	M1.8x0.35	2	6	8	120 Hex	25
IPD/VA-TR-00	-			Flat	2.4	M2x0.4	2.2	5.8	8	120 Hex	25
IPD/XA-TR-00	IPD/XA-TR-00/TIN	Dentium® Implantium® / Superline™	Ø4.0 / Ø4.5 / Ø5.0	120°	2.3	M2x0.4	2.18	8.01	10.2	1.27 Hex	25
		Nobel Biocare® Branemark System®	Ø4.1								
IPD/XA-TR-02	-	Nobel Biocare® Nobel Active®	Ø4.3	Flat	2.52	M2x0.4	1.45	5.9	7.35	120 Hex	30
IPD/YB-TR-00	IPD/YB-TR-00/TIN	Medentis® ICX	RP	30°	2.5	M1.6x0.35	2.92	6.6	9.52	1.40 Hex	30
IPD/ZA-TR-00	-	Bredent® Blue Sky™	Ø3.5/Ø4.5/Ø5.5	120°	2.17	M1.8x0.35	1.75	7.45	9.2	Unigrip Bredent®	25

DESCRIPTION			CHARACTERISTIC								
REFERENCE	COMPATIBILITY	PLATFORM	SEAT	HEAD DIAMETER	METRIC	HEAD (L1)	BODY (L2)	TOTAL (LT)	SCREWDRIVER	TORQUE (Ncm)	
IPD/AA-TN-50	Nobel Biocare® Branemark System®	Ø3.5	70°	2.3	M1.6x0.35	2.08	4.72	6.8	TPA	20	
	Nobel Biocare® Nobel Active®	Ø3.5									
IPD/AA-TR-50	Nobel Biocare® Branemark System®	Ø4.1	75°	2.3	M2x0.4	1.93	3.87	5.8	TPA	25	
	Sweden & Martina® Outlink®										
	Phibo® TSH®	S3-S4									
IPD/AA-TR-52	Nobel Biocare® Branemark System®	Ø4.1	Flat	2.3	M2x0.4	1.4	4.4	5.8	TPA	25	
	Biomet® 3i® Osseotite®	Ø3.25 / Ø4.1 / Ø5.1									
	BTI® External Hex	Ø4.1 / Ø5.5									
IPD/AA-TW-50	Nobel Biocare® Branemark System®	Ø5.1	72°	2.85	M2.5x0.45	1.61	4.8	6.41	TPA	25	
IPD/AB-TR-50	Multi-unit / Multi-im®	Ø4.8	Flat	2.3	M1.4x0.3	1.5	2.1	3.6	TPA	15	
IPD/AB-TR-51	Multi-unit	Ø4.8	Flat	2.25	M1.4x0.3	3.25	2.10	5.35	TPA	15	
IPD/AC-TN-50	Nobel Biocare® Nobel Replace® Select	Ø3.5	Flat	2.25	M1.8x0.35	1.4	6.1	7.5	TPA	25	
IPD/AC-TN-51	Nobel Biocare® Nobel Replace® Select	Ø3.5	Flat	2.25	M1.8x0.35	1.4	5.4	6.8	TPA	25	
	Nobel Biocare® Nobel Replace® Select	Ø4.3 / Ø5.0									
IPD/AC-TR-50	Astra® OsseoSpeed®	Ø4.5-Ø5.0	Flat	2.3	M2x0.4	1.4	7.4	8.8	TPA	25	
	Nobel Biocare® Nobel Replace® Select	Ø4.3 / Ø5.0									
IPD/AC-TR-51	Nobel Biocare® Nobel Replace® Select	Ø4.3 / Ø5.0	Flat	2.3	M2x0.4	1.3	6.8	8.1	TPA	25	
IPD/AD-TR-50	Nobel Biocare® Nobel Active®	Ø4.3	75°	2.3	M2x0.4	2.0	5.0	7	TPA	25	
IPD/AD-TT-50	Nobel Biocare® Nobel Active®	Ø3.0	70°	2.3	M1.4x0.3	2.0	4.65	6.65	TPA	15	
IPD/BB-TR-51	Biomet® 3i® Certain®	Ø3.4 / Ø4.1 / Ø5.0	Flat	2.25	M1.6x0.35	1.35	6.25	7.6	TPA	20	
IPD/CA-TR-50	Klockner® SK2-NK2	Ø4.2	90°	2.3	M1.8x0.35	1.50	3.00	4.5	TPA	25	
IPD/CB-TR-50	Klockner® Essential Cone®	Ø4.5	90°	2.3	M1.8x0.35	1.65	4.85	6.5	TPA	25	
IPD/CD-TN-50	Klockner® Vega®	Ø3.5	90°	2.3	M1.6x0.35	1.65	5.7	7.35	TPA	25	
IPD/CD-TR-50	Klockner® Vega®	Ø4.0 / Ø4.5	90°	2.25	Special	1.8	5.65	7.45	TPA	25	
IPD/DA-TR-50	Straumann® Tissue Level (synOcta® level)	Ø4.8 / Ø6.0	90°	2.3	M2x0.4	1.65	3.32	4.97	TPA	25	
IPD/DA-TR-51	Straumann® Tissue Level (Implant level)	Ø4.8 / Ø6.0	30°	2.3	M2x0.4	2.65	3.65	6.3	TPA	25	
IPD/DB-TR-50	Straumann® Bone Level	Ø3.3 / Ø4.1	30°	2.3	M1.6x0.35	2.15	5.55	7.7	TPA	20	
IPD/EA-TN-50	Astra® OsseoSpeed®	Ø3.0	120°	2.25	M1.4x0.35	1.65	5.45	7.1	TPA	15	
IPD/EA-TR-50	Astra® OsseoSpeed®	Ø3.5-Ø4.0	Flat	2.25	M1.6x0.35	1.35	6.05	7.4	TPA	20	
IPD/EA-TR-51	Astra Uni 20° / 45°	All	Flat	2.3	M1.4x0.3	1.50	2.90	4.4	TPA	15	
IPD/EB-TN-50	Astra® Evolution®	Ø3.6	60°	2.3	M1.6x0.35	1.99	5.11	7.1	TPA	20	
IPD/EB-TR-50	Astra® Evolution®	Ø4.2	100°	2.3	M1.8x0.35	2.22	5.38	7.6	TPA	25	
IPD/FA-TR-50	Zimmer® Screw Vent®	Ø3.5 / Ø4.5 / Ø5.7	140°	2.25	M1.8x0.35	1.73	4.97	6.7	TPA	25	
IPD/GA-TN-50	BTI® External Universal	Ø3.5	Flat	2.3	M2x0.4	1.5	3.6	5.1	TPA	25	
IPD/GB-TR-50	BTI® Interna	Universal® Ø4.1 / Wide Ø5.5	Flat	2.3	M1.8x0.35	1.5	5.0	6.5	TPA	25	
IPD/HA-TN-50	Microdent® Microdent® System	Ø3.5	140°	2.3	M1.8x0.35	1.6	4.0	5.6	TPA	25	
IPD/HA-TR-50	Microdent® Microdent® System	Ø4.2 / Ø5.1	120°	2.3	M2x0.4	1.85	4.15	6	TPA	25	

DESCRIPTION			CHARACTERISTIC								
REFERENCE	COMPATIBILITY	PLATFORM	SEAT	HEAD DIAMETER	METRIC	HEAD (L1)	BODY (L2)	TOTAL (LT)	SCREWDRIVER	TORQUE (Ncm)	
IPD/IA-TR-50	Dentsply® Xive® Friadent®	Ø3.8	90°	2.3	M1.6x0.35	1.66	5.44	7.1	TPA	20	
IPD/IB-TR-51	Dentsply® Ankylos®	C/X	60°	2.3	M1.8x0.35	1.89	5.41	7.3	TPA	25	
IPD/LB-TR-50	BioHorizons® Tapered Internal	Ø3.0 / Ø3.5 / Ø4.5 / Ø5.7	90°	2.3	M1.8x0.35	1.89	4.61	6.5	TPA	25	
IPD/MA-TN-50	Sweden & Martina® Outlink®	Ø3.3	120°	2.3	M1.8x0.35	1.55	4.25	5.80	TPA	25	
IPD/MB-TN-50	Sweden & Martina® Premium™ Kohno®	Ø3.3 / Ø3.8	120°	2.3	M1.8x0.35	1.52	4.88	6.4	TPA	25	
	Phibo® TSH®	S2									
IPD/MB-TR-50	Sweden & Martina® Premium™ Kohno®	Ø4.25 / Ø5.0	120°	2.3	M2x0.4	1.55	4.85	6.4	TPA	25	
IPD/OB-TN-50	Osstem Implant® TSIII	Ø3.5	60°	2.3	M1.55x0.35	1.98	7.52	9.50	TPA	20	
IPD/OB-TR-50	Osstem Implant® TSIII	Ø4.0	90°	2.3	M2x0.4	1.36	6.14	7.50	TPA	25	
IPD/QB-TR-50	Biotech® Dental Kontakt®	RP	90°	2.3	M1.4x0.3	1.75	6.0	7.75	TPA	15	
IPD/RB-TR-50	Neodent® Grand Morse™ GM	GM	60°	2.3	M1.6x0.35	1.98	7.52	9.50	TPA	20	
IPD/SB-TR-50	Bego® Semados®	Ø3.25-Ø3.75 / Ø4.1 / Ø4.5	70°	2.3	M1.80x0.35	1.95	4.95	6.90	TPA	25	
IPD/TA-TT-50	MIS® Seven®	Narrow 3.3	120°	2.3	M1.6x0.35	1.72	4.88	6.6	TPA	25	
IPD/TB-TR-50	MIS® C1/V3®	Standard	120°	2.3	UNF 1-72	2.35	4.85	7.2	TPA	25	
IPD/UB-TN-50	DIO® UFII	NP	90°	2.3	M1.40x0.3	1.6	5.35	6.95	TPA	20	
IPD/UB-TR-50	DIO® UFII	RP	120°	2.3	M2x0.4	1.95	6.55	8.5	TPA	25	
IPD/WA-TR-50	Megagen® AnyOne®	RP	120°	2.3	M2x0.4	1.8	7.95	9.75	TPA	25	
IPD/XA-TR-50	Dentium® Implantium® / Superline™	RP	120°	2.3	M2x0.4	1.8	7.95	9.75	TPA	25	
IPD/YB-TR-50	Medentis® ICX	RP	30°	2.3	M1.6x0.35	3.2	5.25	8.45	TPA	20	

A world map is rendered in a light gray, dotted style. Several blue location pins are scattered across the map, primarily concentrated in Europe and Africa. The background of the entire page is a light blue and white hexagonal pattern, with a network of blue lines and dots at the bottom.

Now you have seen our complete range of products, be part of **ipd**.

www.ipd2004.com





ipd



Download the catalog
in other languages.



Download the English version
of the catalog.



Camí del Mig, 71
08302 Mataró (Barcelona)
Teléfono: (+34) 93 611 80 36

info@ipd2004.com

www.ipd2004.com

